

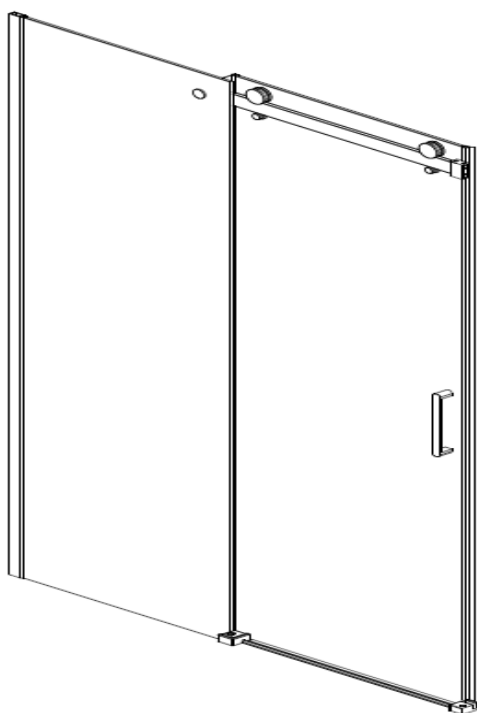

IMPORTANT SAFETY NOTES

- Under no circumstances should you attempt to drill through the glass, damage or injury may occur
- Please handle all glass with care, avoiding knocks and shock loading to all sides and edges. Safety glass cannot be reworked.
- Care should be taken when drilling into walls to avoid hidden pipes or electrical cables.



Ravenna 17 Door Only



Scan this QR code for installation video.

Tools Required

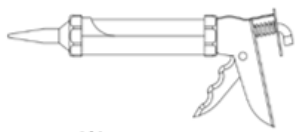

Silicone Gun

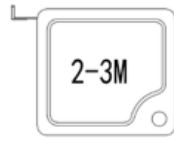

Tape Measure



Scissors

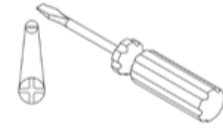

Philips Screwdriver



Hammer



Allen Keys

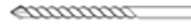

Drill Bit



Pencil



Power Drill



Level

Two people required. We recommend that a technically competent installer should undertake this installation.

Be sure you have all included parts and tools required before beginning installation and that you have plenty of space for assembly.

If you have ordered this shower enclosure with one of our shower trays, **please note** that tiling should be done before the shower tray is installed. This is so that the shower tray can be pushed up against the tiles and sealed with silicone.

PRE-INSTALLATION AND TECHNICAL REQUIREMENTS









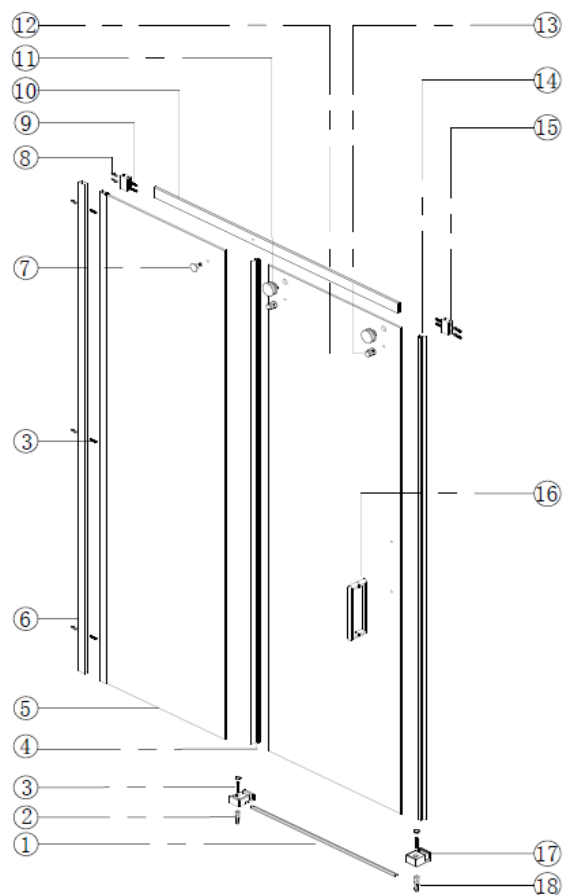







- All dimensions are shown in millimetres, except where otherwise indicated.
- Ensure that the enclosure set is fitted to a level floor and vertical wall surface.
- This instruction manual is applicable for both pre-tiled wall and plain walls.
- The wall fixings included with this product are suitable for solid walls only. Plasterboard or stud walls may require specialist fixings (not supplied).
- Due to the possibility of residual spray, the area around the outside of the shower tray should be tiled, or made otherwise water resistant.

IMPORTANT SAFETY NOTES

- Under no circumstances should you attempt to drill through the glass, damage or injury may occur
- Please handle all glass with care, avoiding knocks and shock loading to all sides and edges. Safety glass cannot be reworked.
- Care should be taken when drilling into walls to avoid hidden pipes or electrical cables.

Included Parts

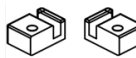

Ref	Description	Illustrations	Qty	Ref	Description	Illustration	Qty
①	Bottom Door Seal		1	⑩	Supporting Bar		1
②	Glass Fixing Piece		(R/L) 1	⑪	Door Rollers		2
③	ST4*40		8	⑫	Glass Door		1
④	Door Seal		1	⑬	Supporting Bar Stabilisers		2
⑤	Glass Side Panel		1	⑭	Door Seal		1
⑥	Aluminium Profile		1	⑮	Supporting Bar Bracket		2
⑦	Supporting Bar Fixing Pieces		1	⑯	Handle		1
⑧	Wall Plugs		2	⑰	Glass Fixing Piece		(R/L) 1
⑨	ST5*40		2	⑱	Wall Plugs		8

Note: The aluminium bars need to be cut to length. Please find the required length shown on the table based on your shower enclosure's door size.

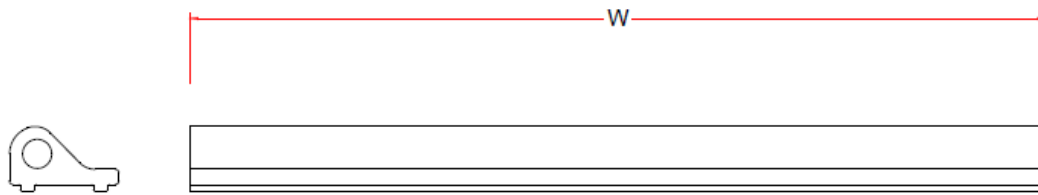

Door Size (mm)	Weather bar W (mm)
1050/1000*1950	490
1150/1100*1950	540
1250/1200*1950	590
1350/1300*1950	640
1400/1450/1550*1950	690
1500/1600*1950	740

Attention: Please cut this aluminium bar from right side, make sure the distance between the hole and the edge match the one shown on this diagram.

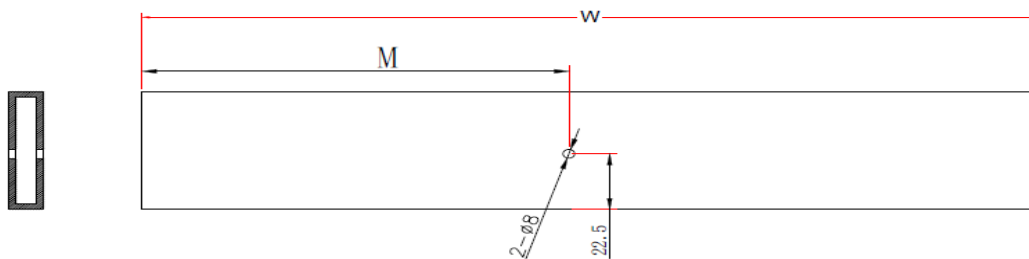

Door Size (mm)	W (mm)	M (mm)
1000*1950	970	395
1050*1950	1020	445
1100*1950	1070	
1150*1950	1120	495
1200*1950	1170	
1250*1950	1220	545
1300*1950	1270	
1350*1950	1320	595
1400*1950	1370	
1450*1950	1420	645
1500*1950	1470	
1550*1950	1520	745
1600*1950	1570	

Aluminium Profile assembly

1. Measure the distance from the wall to where your shower door will be fitted.

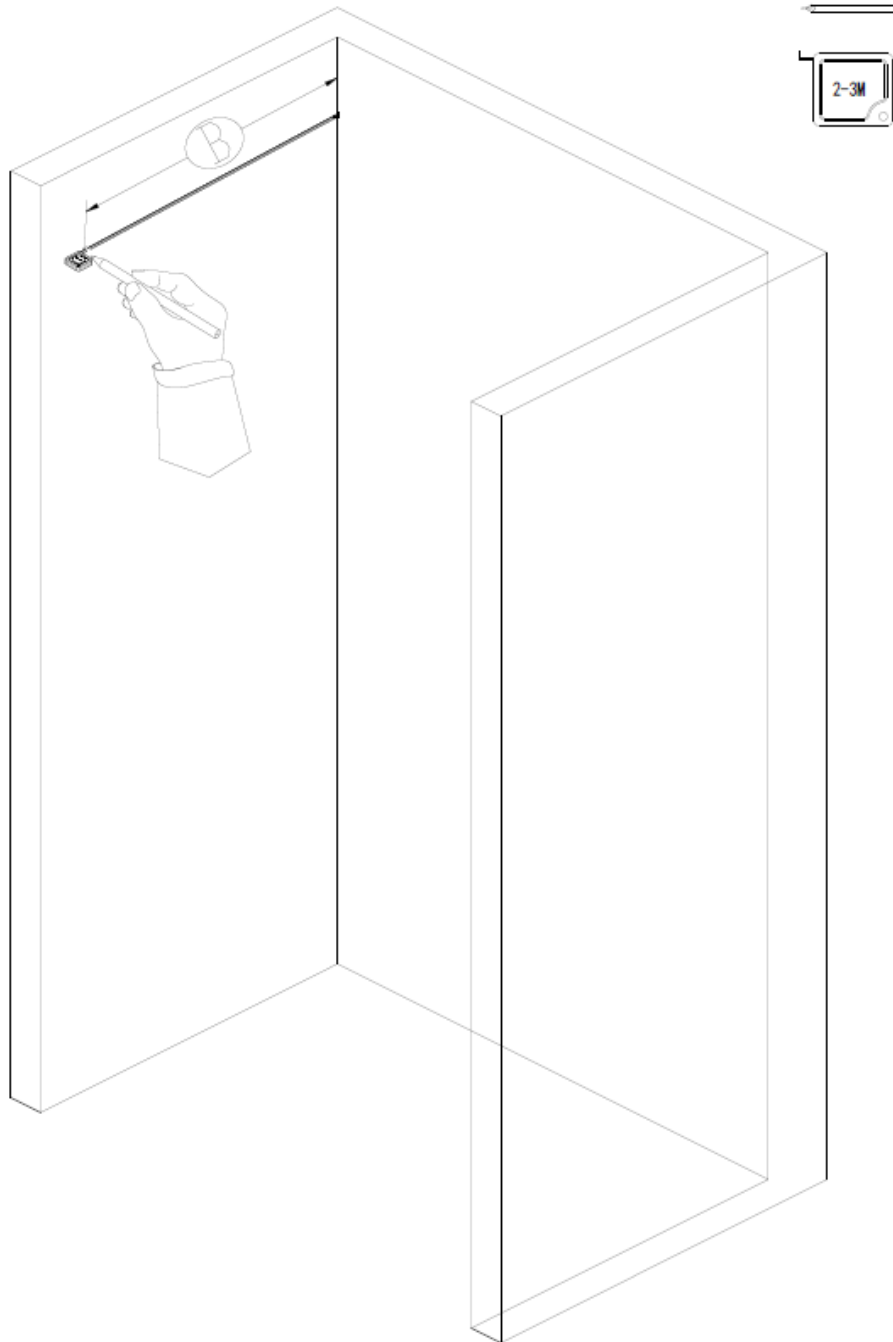

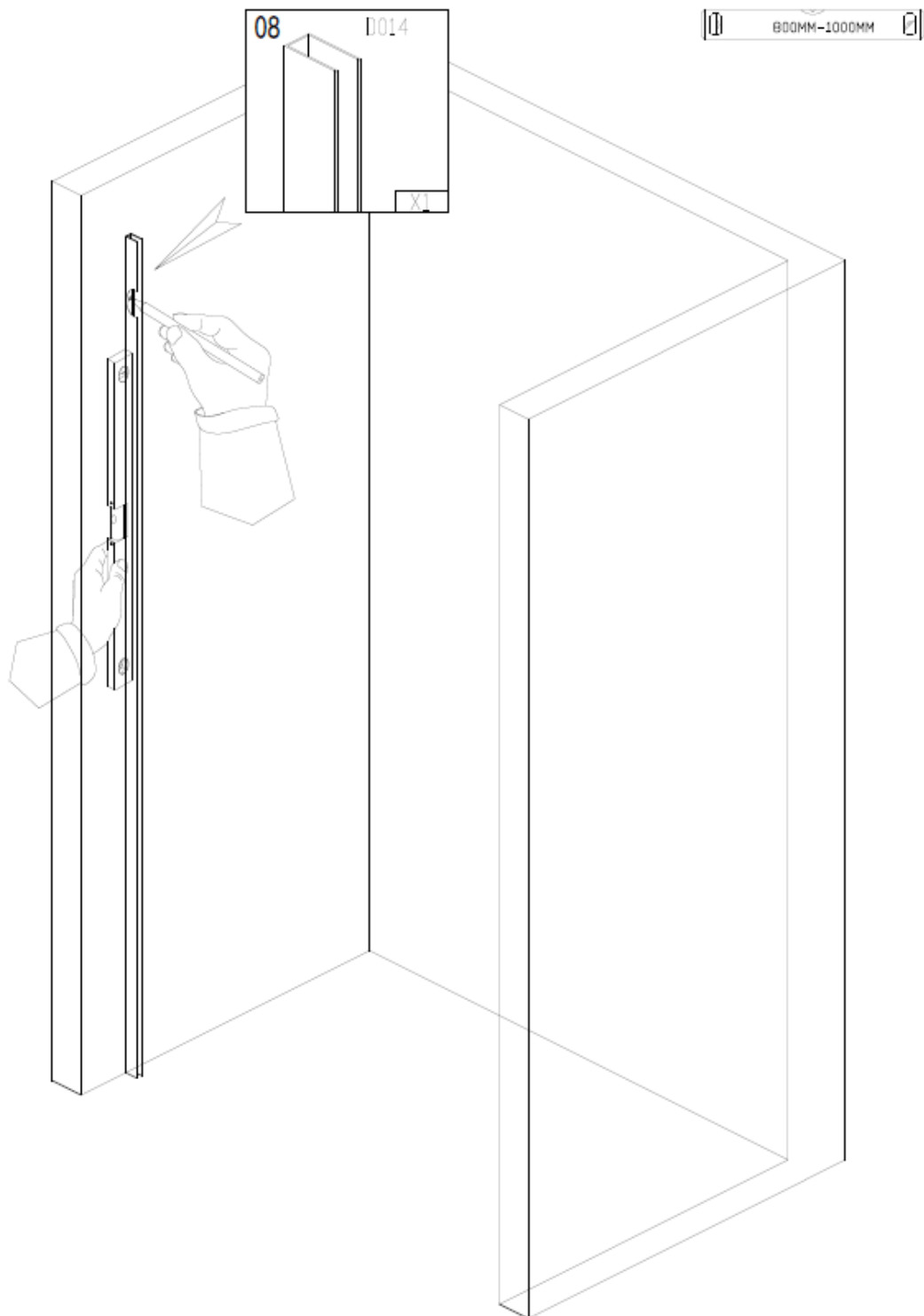

2. Place the aluminium profile against the wall, using a spirit level and a pencil to mark where holes will be drilled.

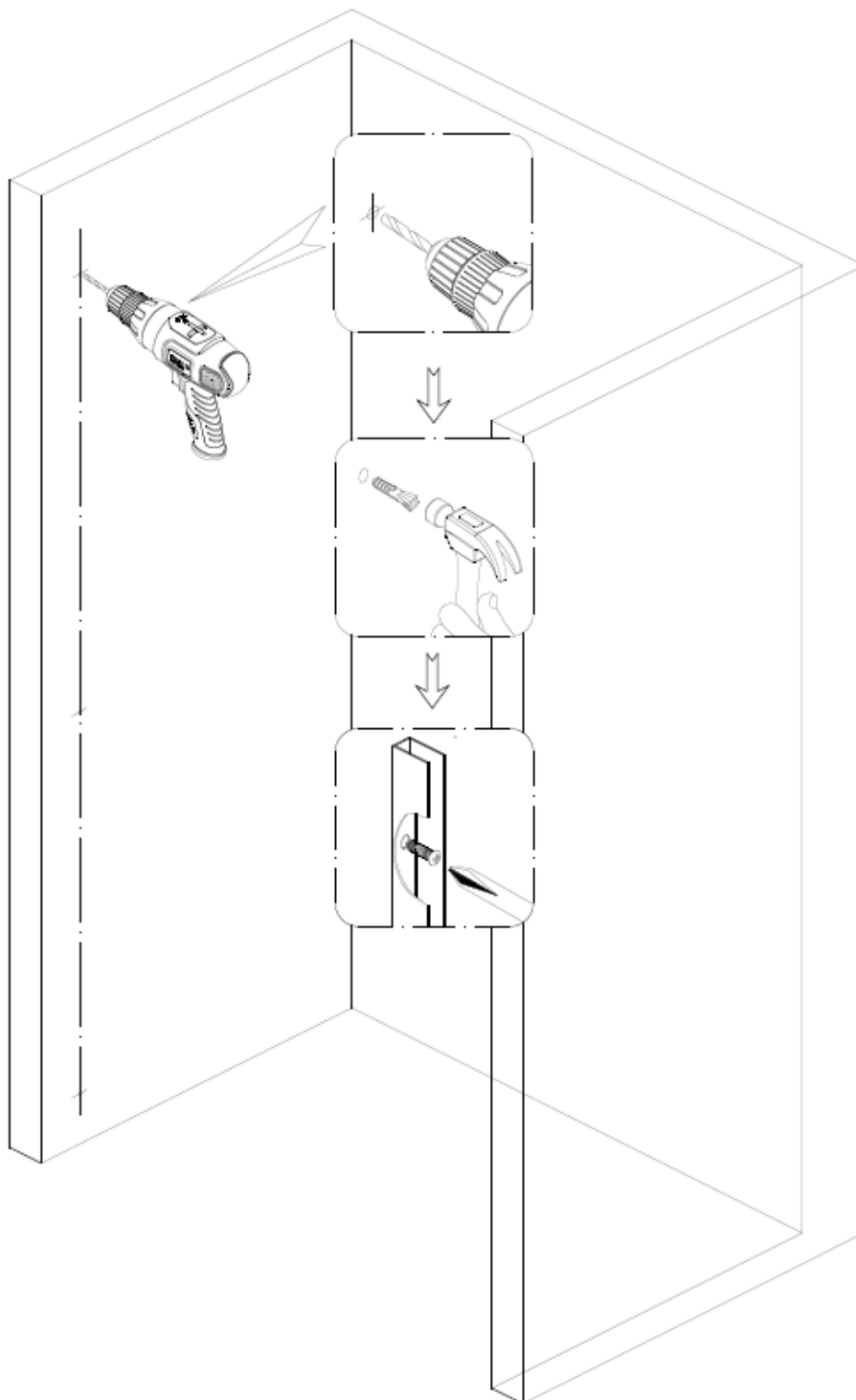

3. Drill the holes and insert wall plugs.
4. Screw the aluminium profile onto the wall.

Glass side panel assembly

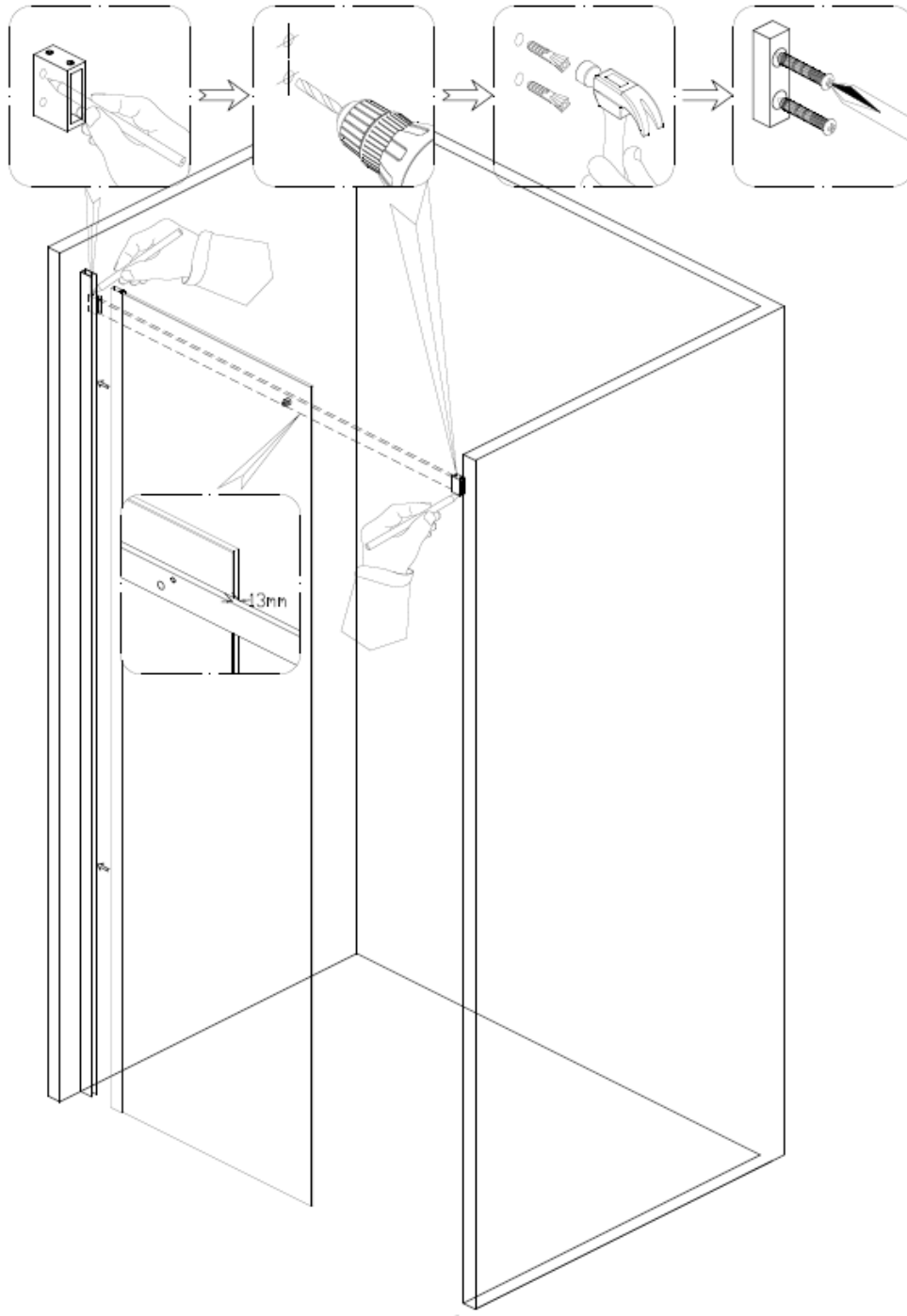

5. Place the supporting bar brackets in place on each wall, marking where holes will be drilled.
6. Drill holes and insert wall plugs.
7. Screw the brackets to the walls.
8. Carefully lift the glass side panel into place

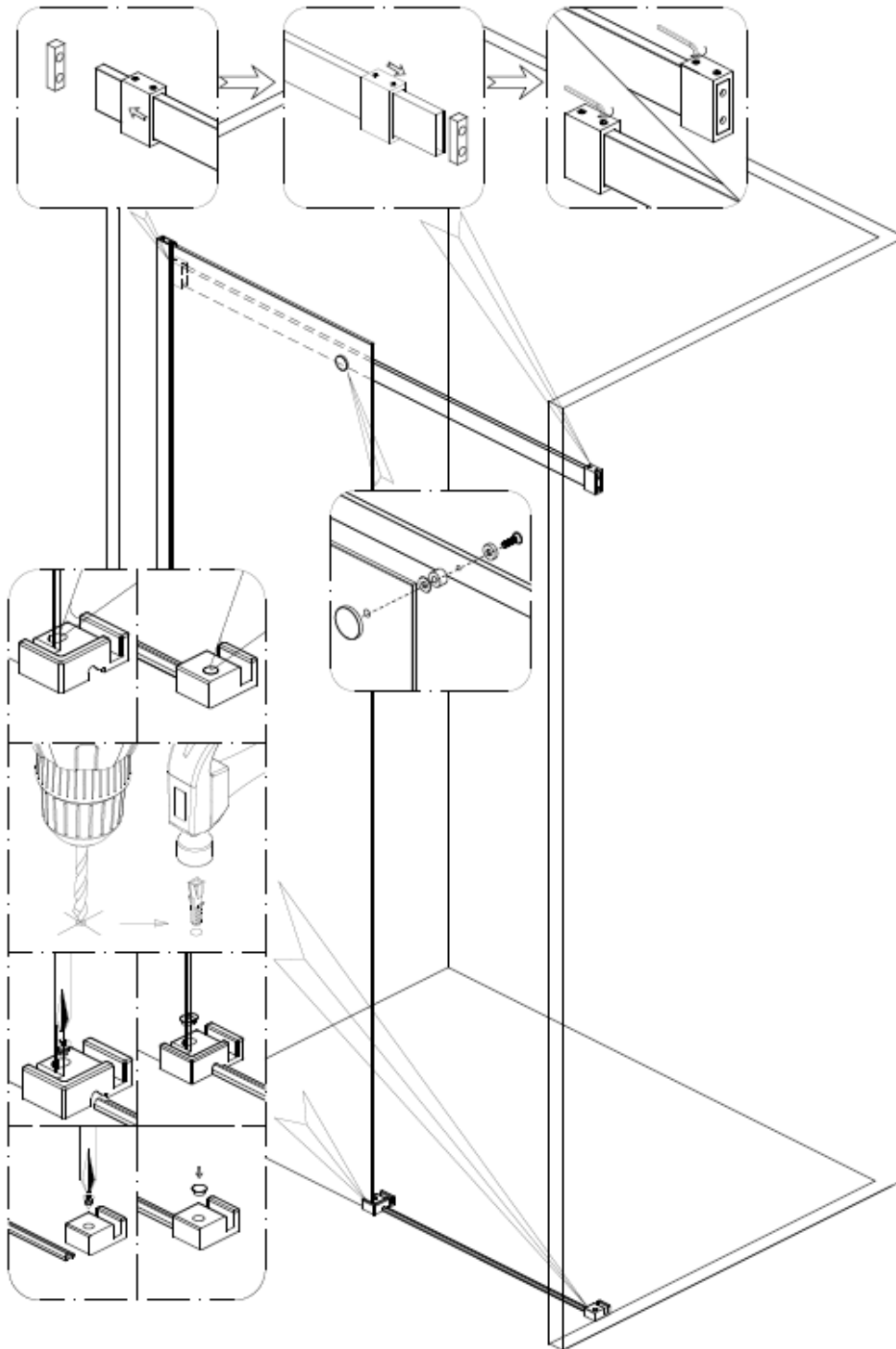

9. Attach the supporting bar to its brackets and the glass side panel.
10. Slide the glass fixing pieces into place, marking where holes will be drilled.
11. Drill holes, insert plugs and screw them into place.

Glass door panel assembly

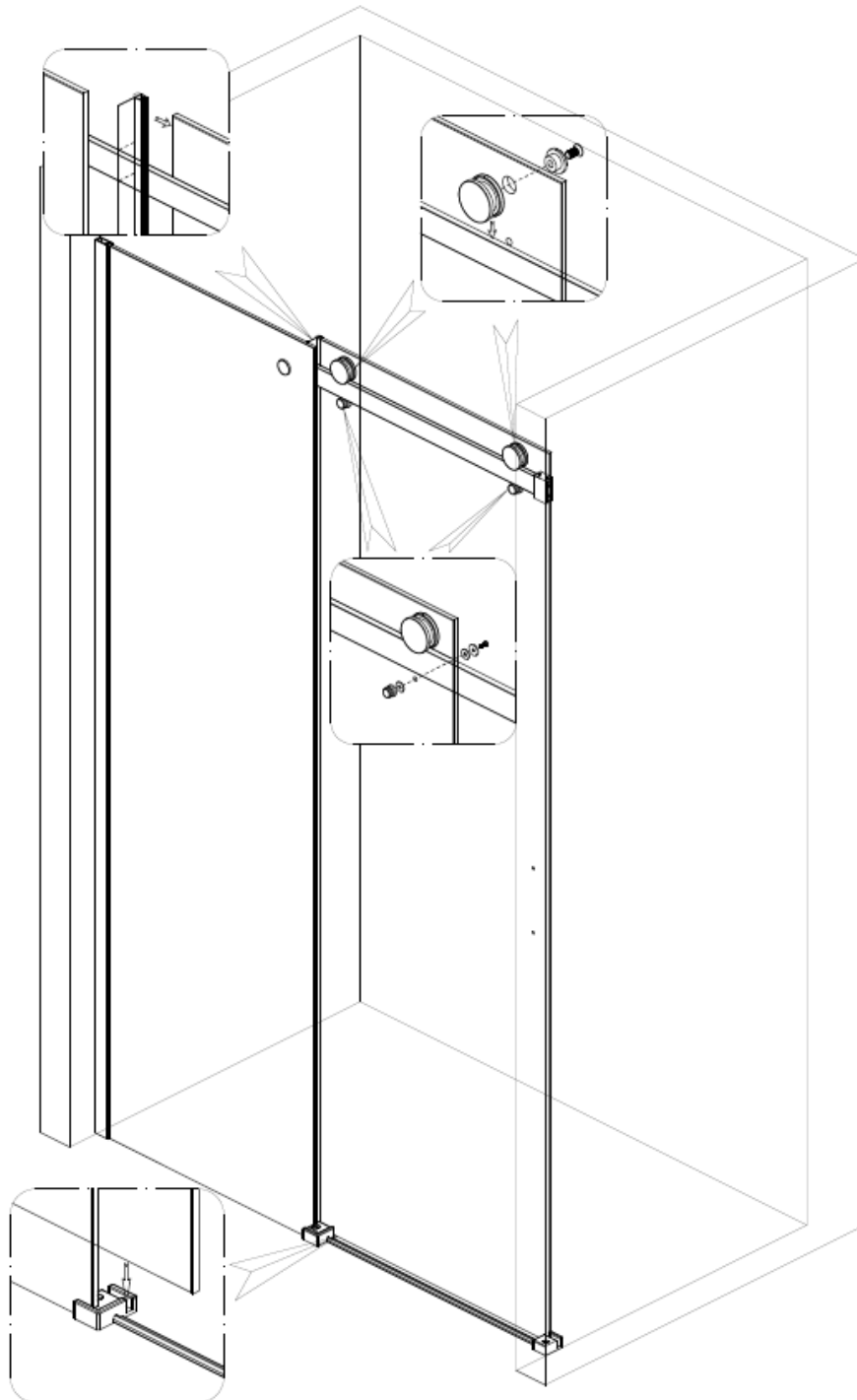

12. Attach left seal to the glass door.
13. Attach rollers to the glass door.
14. Carefully lift the glass door into place.

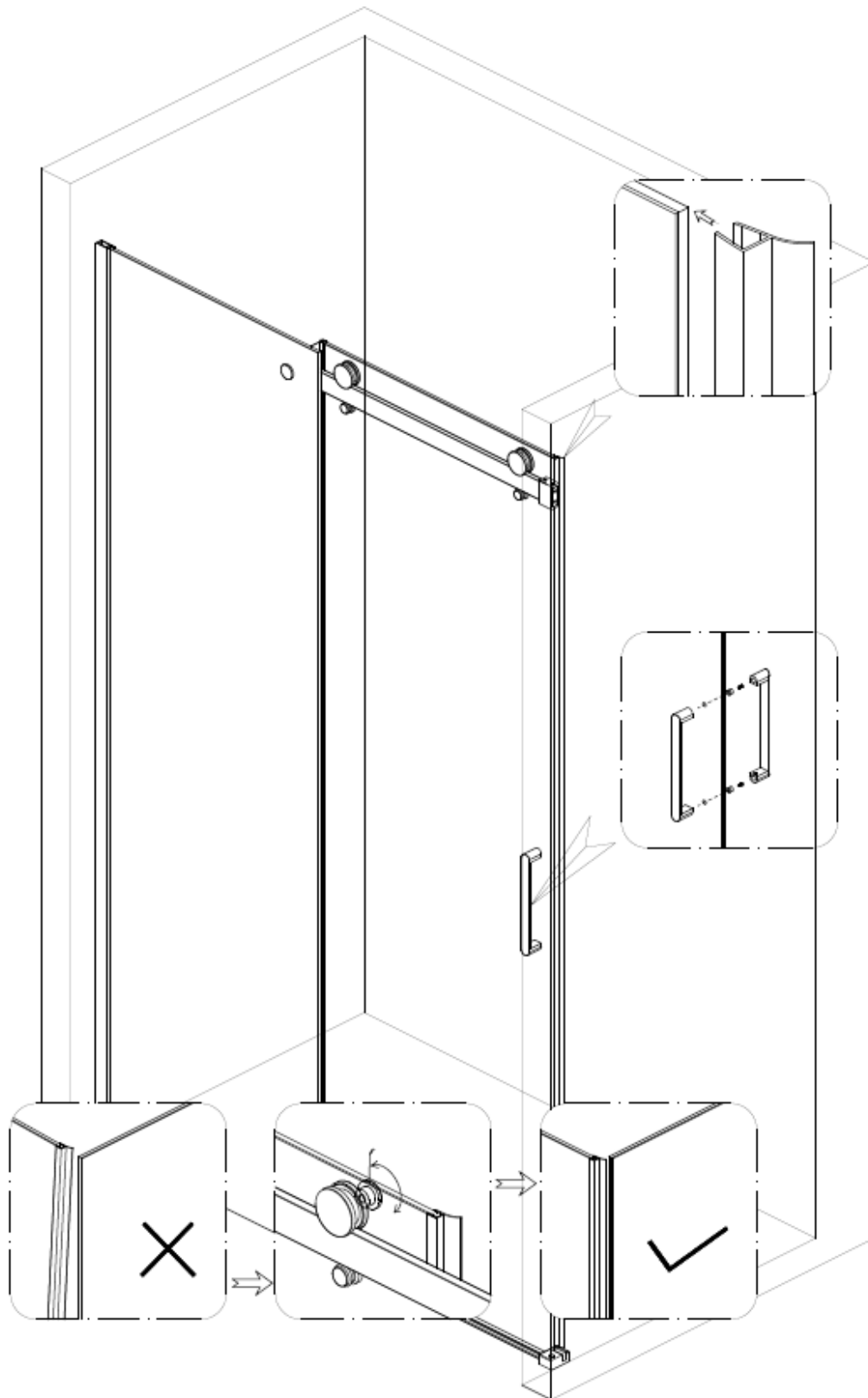

15. Attach the right door seal.
16. Attach the handle to the glass door.
17. Tighten the rollers if necessary.

Apply silicone sealant

18. Insert caps onto the rollers.
19. Silicone and allow to dry for 24 hours.

