

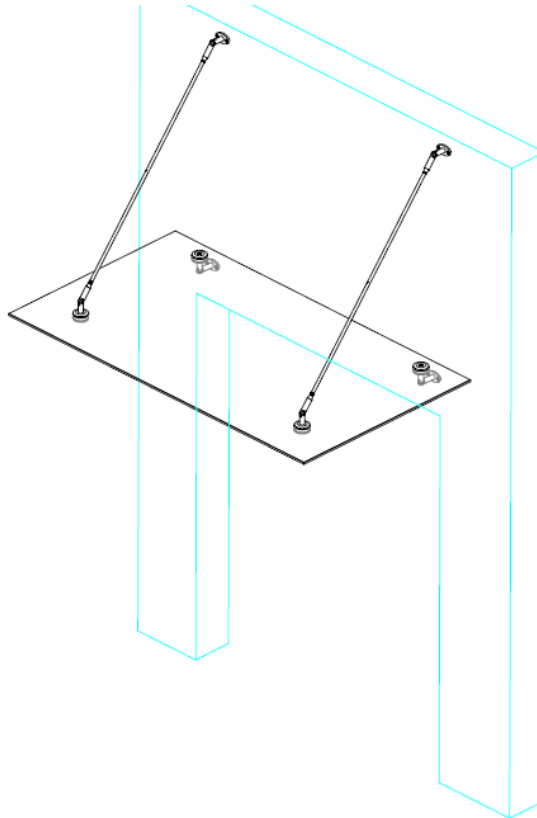

**DUROVIN**  
BATHROOMS

#### IMPORTANT SAFETY NOTES

- Under no circumstances should you attempt to drill through the glass, damage or injury may occur
- Please handle all glass with care, avoiding knocks and shock loading to all sides and edges. Safety glass cannot be reworked.
- Care should be taken when drilling into walls to avoid hidden pipes or electrical cables.



## Glass Canopy 2 Hole Instruction

# Tools Required

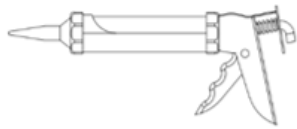

Silicone Gun

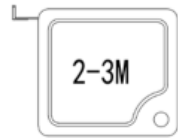

Tape Measure



Scissors

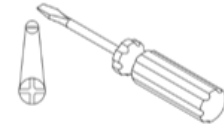

Philips Screwdriver



Hammer



Allen Keys

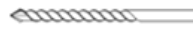

Drill Bit



Pencil



Power Drill



Level

Two people required. We recommend that a technically competent installer should undertake this installation.

Be sure you have all included parts and tools required before beginning installation and that you have plenty of space for assembly.

## PRE-INSTALLATION AND TECHNICAL REQUIREMENTS

- All dimensions are shown in millimetres, except where otherwise indicated.
- Ensure that the enclosure set is fitted to a level floor and vertical wall surface.
- This instruction manual is applicable for both pre-tiled wall and plain walls.
- The wall fixings included with this product are suitable for solid walls only. Plasterboard or stud walls may require specialist fixings (not supplied).
- Due to the possibility of residual spray, the area around the outside of the shower tray should be tiled, or made otherwise water resistant.

## IMPORTANT SAFETY NOTES

- Under no circumstances should you attempt to drill through the glass, damage or injury may occur
- Please handle all glass with care, avoiding knocks and shock loading to all sides and edges. Safety glass cannot be reworked.
- Care should be taken when drilling into walls to avoid hidden pipes or electrical cables.



03

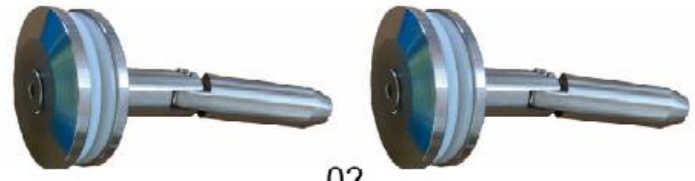

02



07



04



05-06

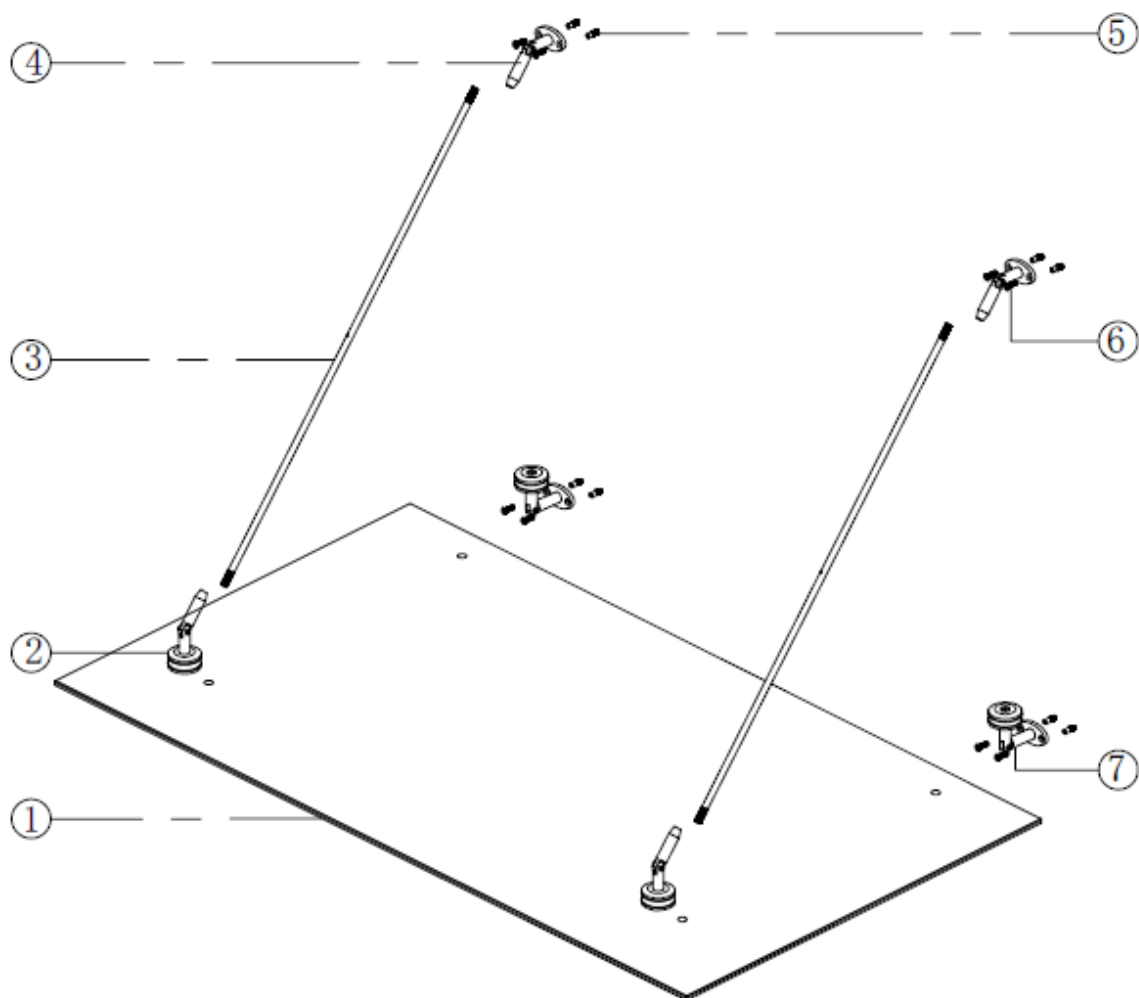

02	03	04
x2	x2	x2
05	06	07
x2	x2	x2

021300026

Montage VDG02 Zugstange Dorano Zugstange (x1) ②

800MM-1000MM

