

**WARNING:** Risk of personal injury or product damage Handle vitreous ceramic products very carefully. Vitreous china can break and chip if you over tighten bolts and nuts.

**WARNING:** Risk of external leakage. The fill valve nut has been factory-tightened to design specifications. If re-tightening is required, wrench tighten one turn past finger tight

**IMPORTANT:** Make sure the supply pressure is a minimum of 35 psi (2.5 kg/cm<sup>2</sup>) The toilet will not function properly without minimum Pressure.



## Wall-hung Ceramic Toilet Instruction



Scan this QR code for installation video.

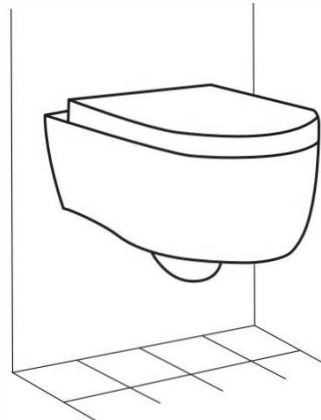

## Before installation

1. Learn local rules on reserved water supply pipe and drainage pipe.
2. Please open the product package and examine if there is any damage.
3. Please read the instruction carefully to know all the tools and spare parts required as well as installation steps, in order to avoid any kind of lost because of improper installation.
4. Because of the fragile property of ceramic products, please lay the product gently and do not fasten the screw too firmly.
5. Please make sure the external water supply is closed

### Note:

All the data in this instruction are based on the newest product before printing. our company owns the rights to revise the product property, package and spare parts supply and no further notice is given

Tools & spare parts required during installation  
( not supplied together with product)



screw driver



Wrench



Tape measure



Spirit level



Hand saw



Drill

# Important notice :

Please choose the wall hidden cistern and read the installation instruction carefully  
Install the hidden cistern and its supporting frame according to the instruction  
Please make sure that the metal frame is strong enough to bear a burthen above 400kg from the toilet. please locate the installing position and decide the ffl based on indoor decoration plan and mark line on wall

## Notice :

Please install the product before putting it on ceramic tiles. all the units here are "mm" and ffl refers to the finish floor level

### 1. laying drainage pipe

Figure 1-3 shows an example of pipe installation; please decide how to install the pipes according to the position of drainage outlet; if the position of the drainage outlet belongs to none of the above ways, please lay the drainage pipe as the figure shows

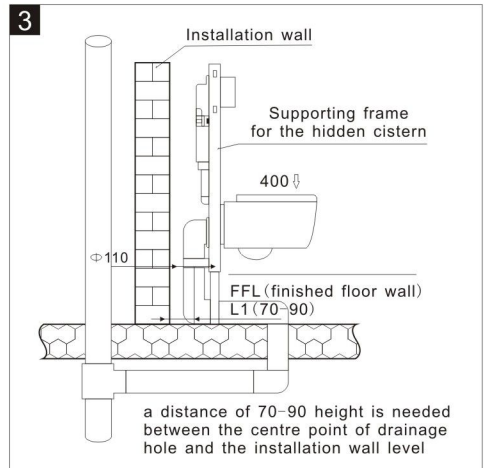
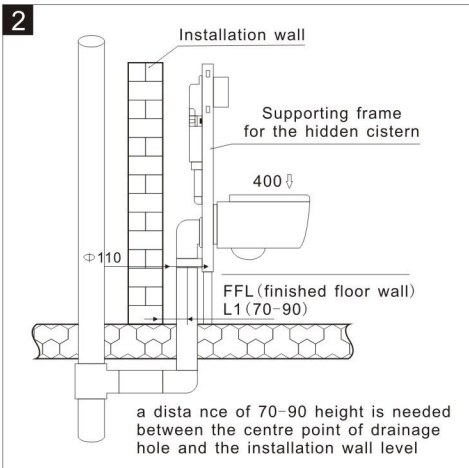
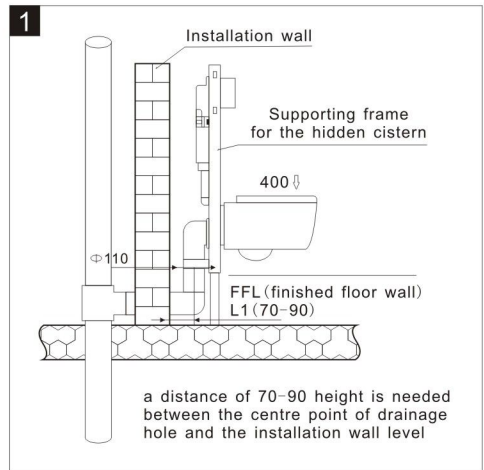

2. please lay the water supply pipe according to the instruction of hidden cistern

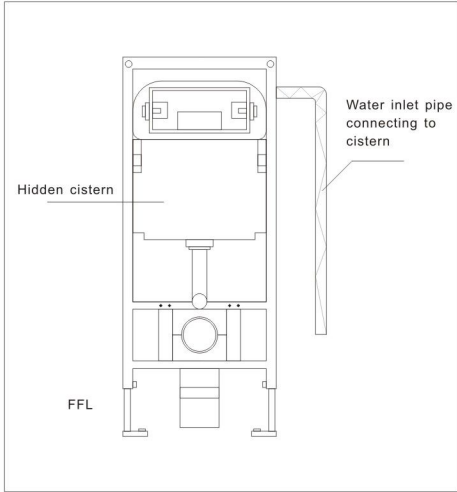

3. please install the supportingframe according to instruction

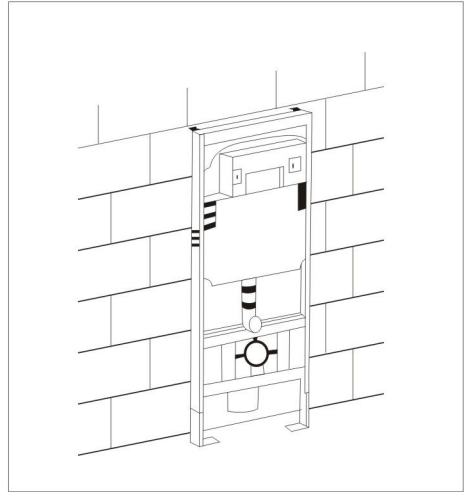

4. building the wall

The thickness range of the decorative wall should refer to the instruction for hidden cistern; 10.5-33mm thickness is advice thickness between the outside level of the supporting frame and the finished wall after tiling)

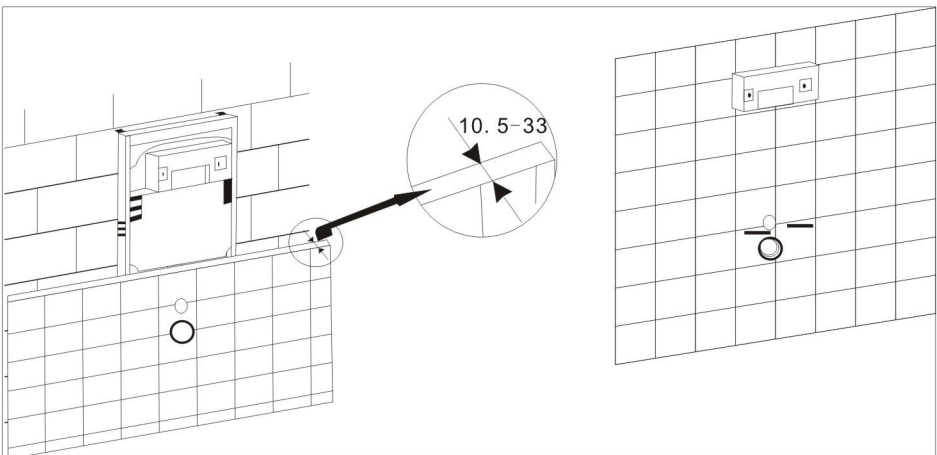

## 5. Installation of Ceramic Toilet

### 1 Decide the size of drainage pipe

a). insert pipes into the water inlet and outlet pipe until they could not move forward t mark a crossing line on wall between the pipe and the wall level

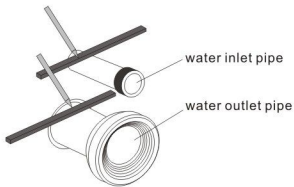

b). insert the pipes into the toilet until they could not move forward mark cross lines from pipe and toilet back side level

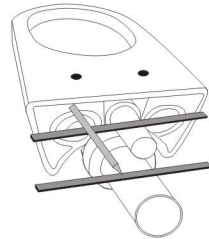

c). cut off the connecting pipe: the cut length should be the sum length of lines in a) & b) and the length showing in the below figure

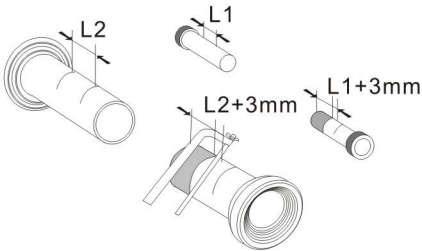

d). beveling a 45° angle on the outlet of connecting pipe

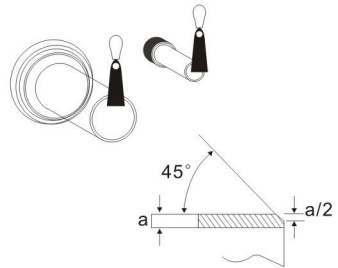

### 2 Instal the connecting bolt

a). use hexagonal key to screw the conical nut into mounting fittings

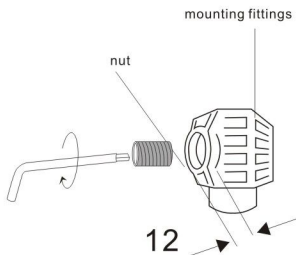

b). insert the auxiliary part into the aiming screw by pushing the part to the top from its flat surface.

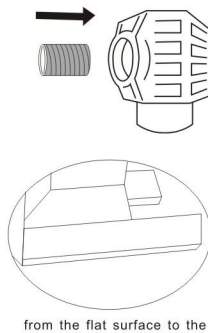

c). the auxiliary part is totally inserted into the aiming screw.

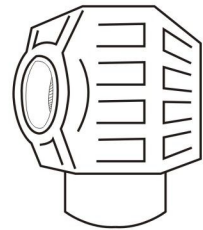

d). put the mounting fittings into the installation hole on toilet

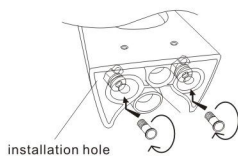

e). turn the toilet and make the installation hole vertically upside. the leg side of screw should lock the fixed position on back side of toilet

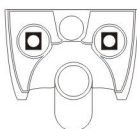
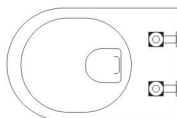

f). adjust the position of bearing bolt well and screw it into the connecting bolt

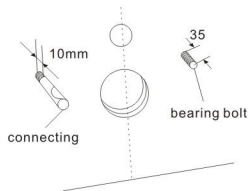

### 3 installation of toilet pan

a). insert the connecting pipe into the pan

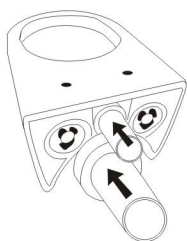

b) spread lubricating oil on the joint area between connection pipe and water inlet & outlet to make the connection more smooth

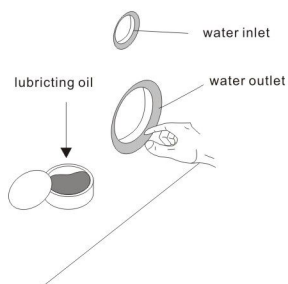

c). smear few glass cement around the bottom edge to fill the interspace between toilet and wall

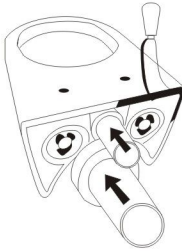

d). lift up the toilet and point it accurately into the water inlet and outlet: make sure that the installation hole passes through the connecting bolt and push the bolt into the hole until it touches the wall

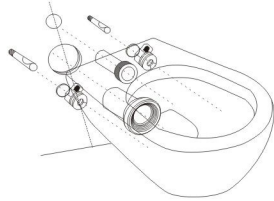

e) fasten the cone-shape screw through the installation hole on toilet cover by allen key

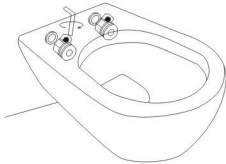

f). shake the toilet gently by hand to check if the screw is firm enough

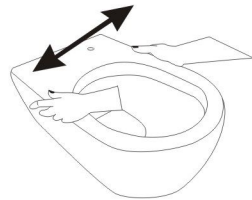

g). install the toilet cover according to the instruction provided by toilet cover producer



h). apply glass cement between the toilet and wall

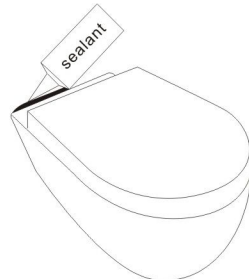

## 6. installation instruction of hidden cistern

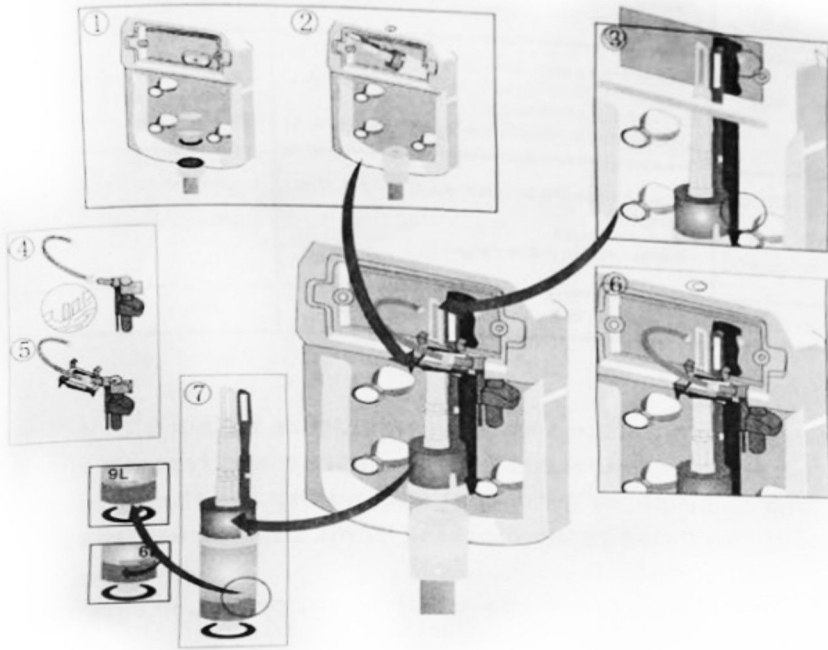

### **Warning:**

1. please check if all the connecting joints are tight enough or if there is any leakage after the installation of drainage fittings
2. it's absolutely forbidden to firm the toilet with cement, or it may make the toilet crack.
3. water inlet pipe, angle valve and water parts should be firm enough to avoid leakage problem.
4. the installation of various water parts and the connection of water tank and pan should be correct and firm or it may lead to leakage and abnormal flushing problems.



## Trouble-shooting instruction

Trouble	Cause	solution
No water coming in	1. water inlet valve not open 2. water inlet filter blocked 3. water inlet float ball stuck	1. Open the main valve 2. Clean the flitar 3. Adjust the float ball
Flushing wate not enough	1. water inlet valve is too low 2. mandril of flushing button does not reach to the flushing mechanism. 3. press the small button but not large button	1. Adjust the inlet valve to a sutable level 2. Adjust the mandril 3. Distinguish the small and large button of contact with suoolier.
water draining out too slowly (suction is not enough)	1. Drain hole is not pointed accurately during installation 2. Sewer bolcked 3. water volume not enough.	1. Adjust or re-install 2. Clean or dredge the sewer 3. Adjust the water volume in watertank
Toilet swinging around	1. the fixing bolts not tightened enough	1. Fix the screw

### Notice :

1. please do not use the product in a water temperature below 0°C. when the environmental temperature below 0°C, please cleanse and remove the water inside of water tank and pipe, or it may get ice and expand the product
2. it's forbidden to throw those easily blocking items such as newspaper, diaper and sanitary napkin into the product
3. it's forbidden to impact the ceramic part with heavy power, in case of breakage and leakage
4. in order to keep its normal flushing function, please use toilet brush with long handle or neutral cleaning agent to clean water hole and drain sewer it's advised to clean the product once every week
5. please cleanse the filter device at least once in every month , in case that little water or no water fills into water tank

### Notice& maintenance of toilet cover in using

1. please do not put the toilet cover under sunshine or near any heat source, or expose it in lampblack
2. please do not use any kind of sharp object such as wire brush or knife to cleanse the cover.
3. please do not use propellant, diluents or any other chromium oxides to clean the cover
4. please do not lay heavy objects such as tank lid, flowerpot, bucket or salver on the cover

Any kind of violation against the above tips may lead problems such as color fading and changing .deformation,cracking.scratches and so on.