

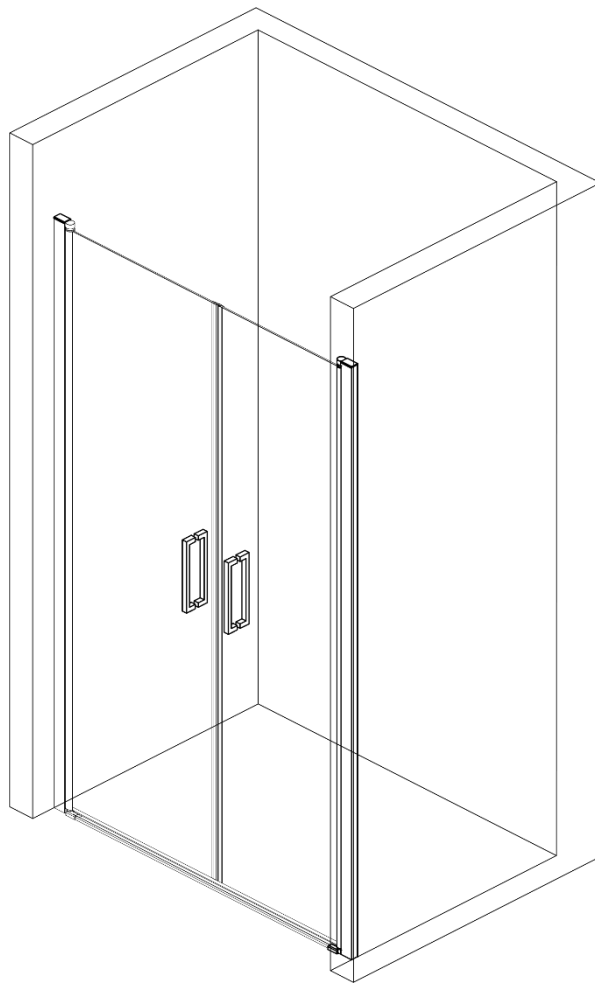

#### IMPORTANT SAFETY NOTES

- Under no circumstances should you attempt to drill through the glass, damage or injury may occur
- Please handle all glass with care, avoiding knocks and shock loading to all sides and edges. Safety glass cannot be reworked.
- Care should be taken when drilling into walls to avoid hidden pipes or electrical cables.



**Teramo 22 Double Door**

# Tools Required

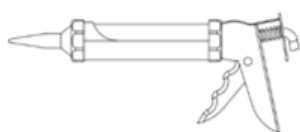

Silicone Gun

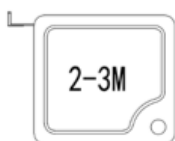

Tape Measure



Scissors

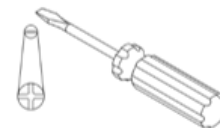

Philips Screwdriver



Hammer



Allen Keys

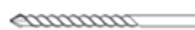

Drill Bit



Pencil

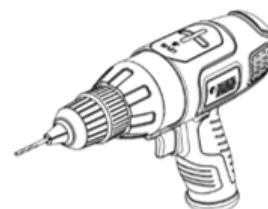

Power Drill



Level

Two people required. We recommend that a technically competent installer should undertake this installation.

Be sure you have all included parts and tools required before beginning installation and that you have plenty of space for assembly.

If you have ordered this shower enclosure with one of our shower trays, **please note** that tiling should be done before the shower tray is installed. This is so that the shower tray can be pushed up against the tiles and sealed with silicone.

## PRE-INSTALLATION AND TECHNICAL REQUIREMENTS









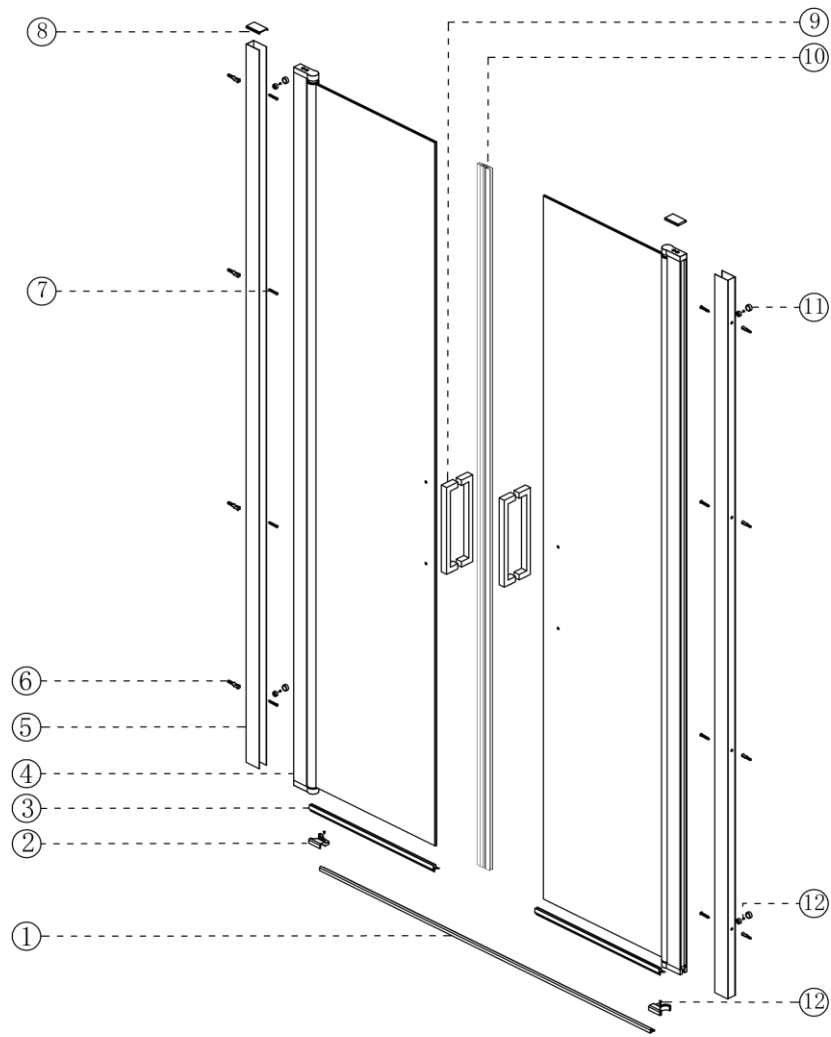

- All dimensions are shown in millimetres, except where otherwise indicated.
- Ensure that the enclosure set is fitted to a level floor and vertical wall surface.
- This instruction manual is applicable for both pre-tiled wall and plain walls.
- The wall fixings included with this product are suitable for solid walls only. Plasterboard or stud walls may require specialist fixings (not supplied).
- Due to the possibility of residual spray, the area around the outside of the shower tray should be tiled, or made otherwise water resistant.

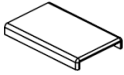
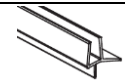
## IMPORTANT SAFETY NOTES

- Under no circumstances should you attempt to drill through the glass, damage or injury may occur
- Please handle all glass with care, avoiding knocks and shock loading to all sides and edges. Safety glass cannot be reworked.
- Care should be taken when drilling into walls to avoid hidden pipes or electrical cables.

# Included Parts



Ref	Description	Illustrations	Qty	Ref	Description	Illustration	Qty
①	Weather Bar		1	⑦	Screws		8
②	Fixing Pieces		(R/L) 2	⑧	Aluminium Profile Caps		2
③	Seals		2	⑨	Handles		2
④	Glass Doors		2	⑩	Seals		2
⑤	Aluminium Profiles		2	⑪	Caps		4
⑥	Plugs		10	⑫	Screws		6

# Aluminium Profile assembly

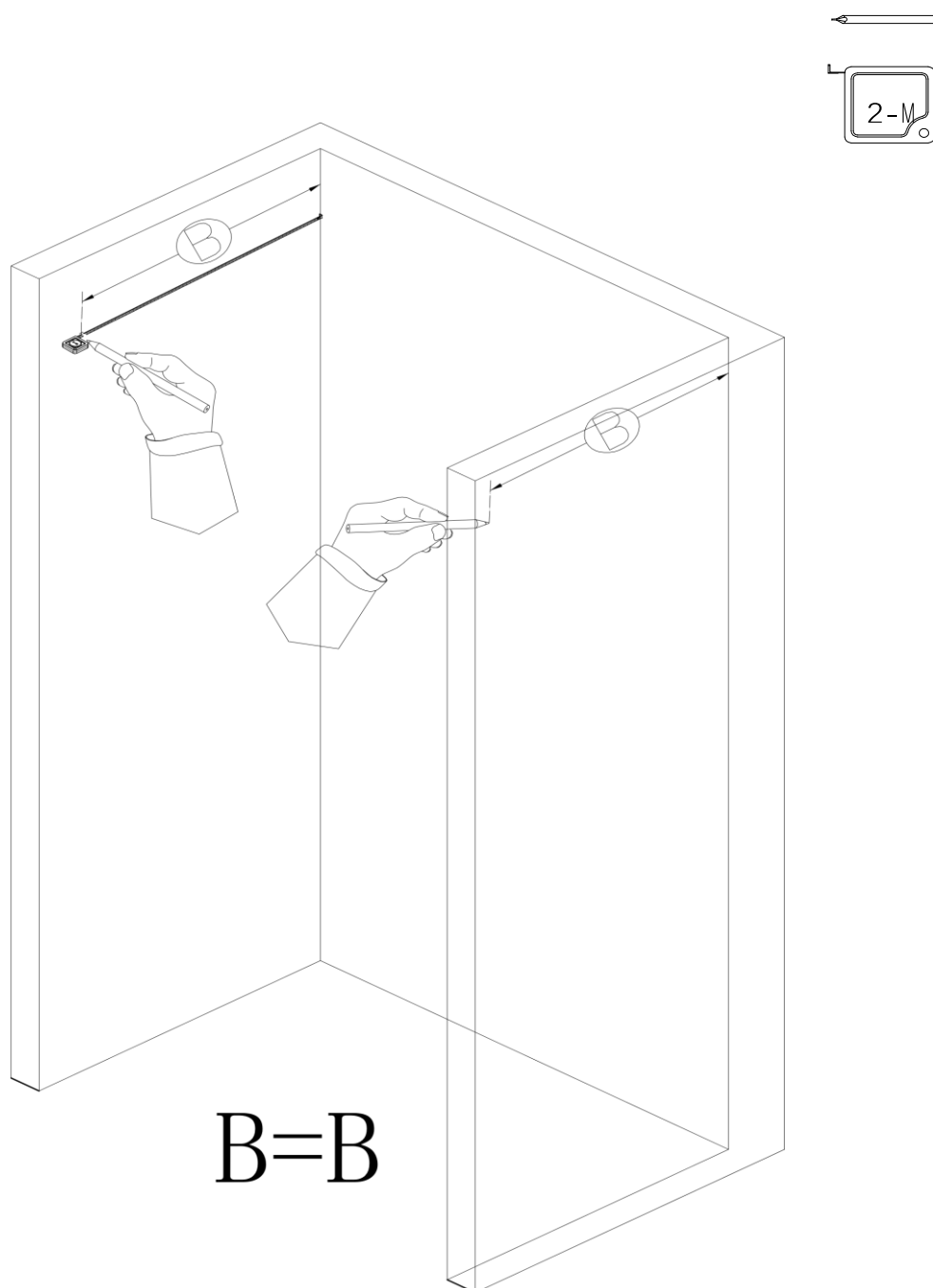

1. Measure how far forwards your shower door will sit.

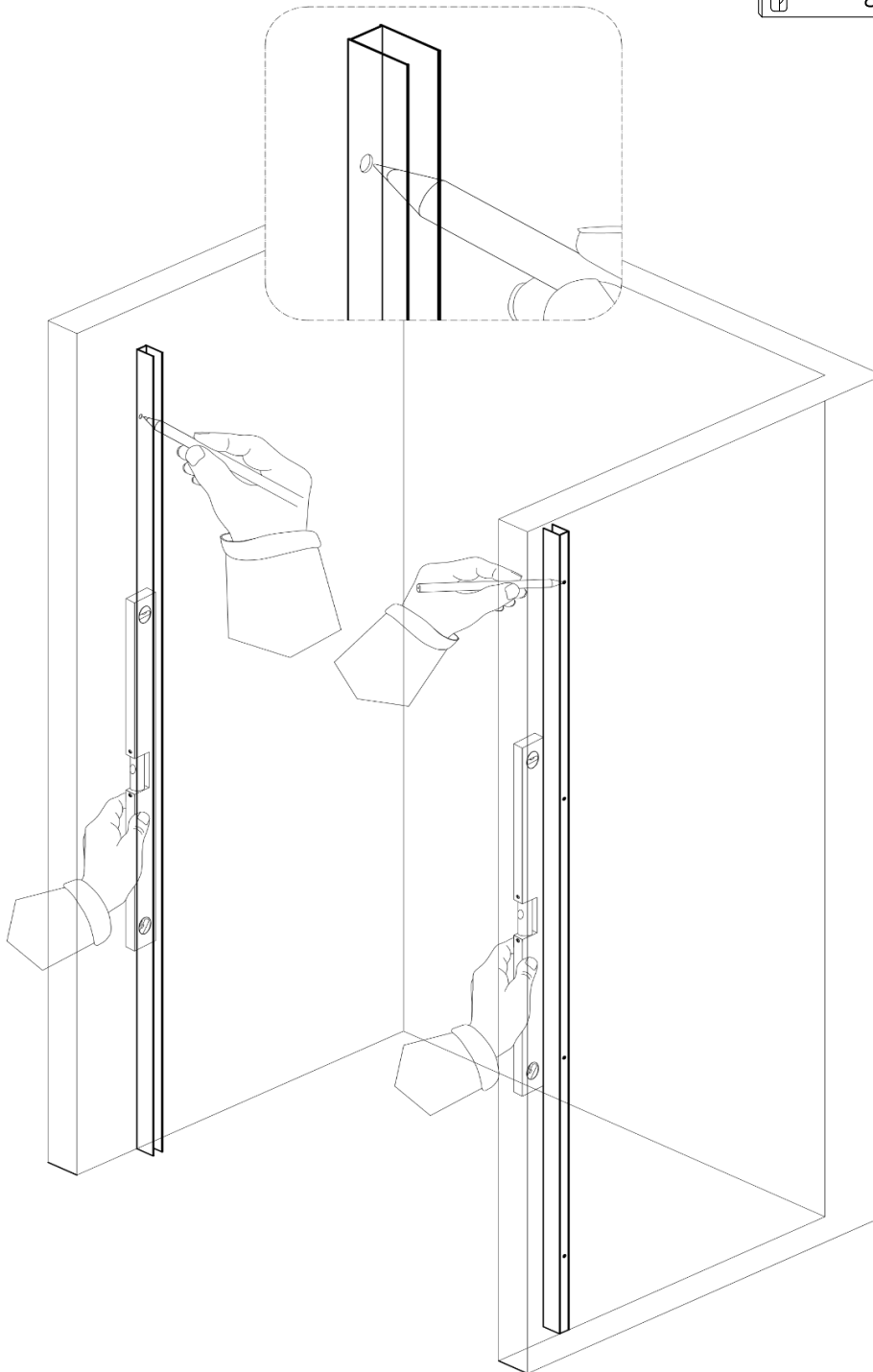

2. Using a spirit level, place the aluminium profiles against each wall, marking where holes will be drilled.

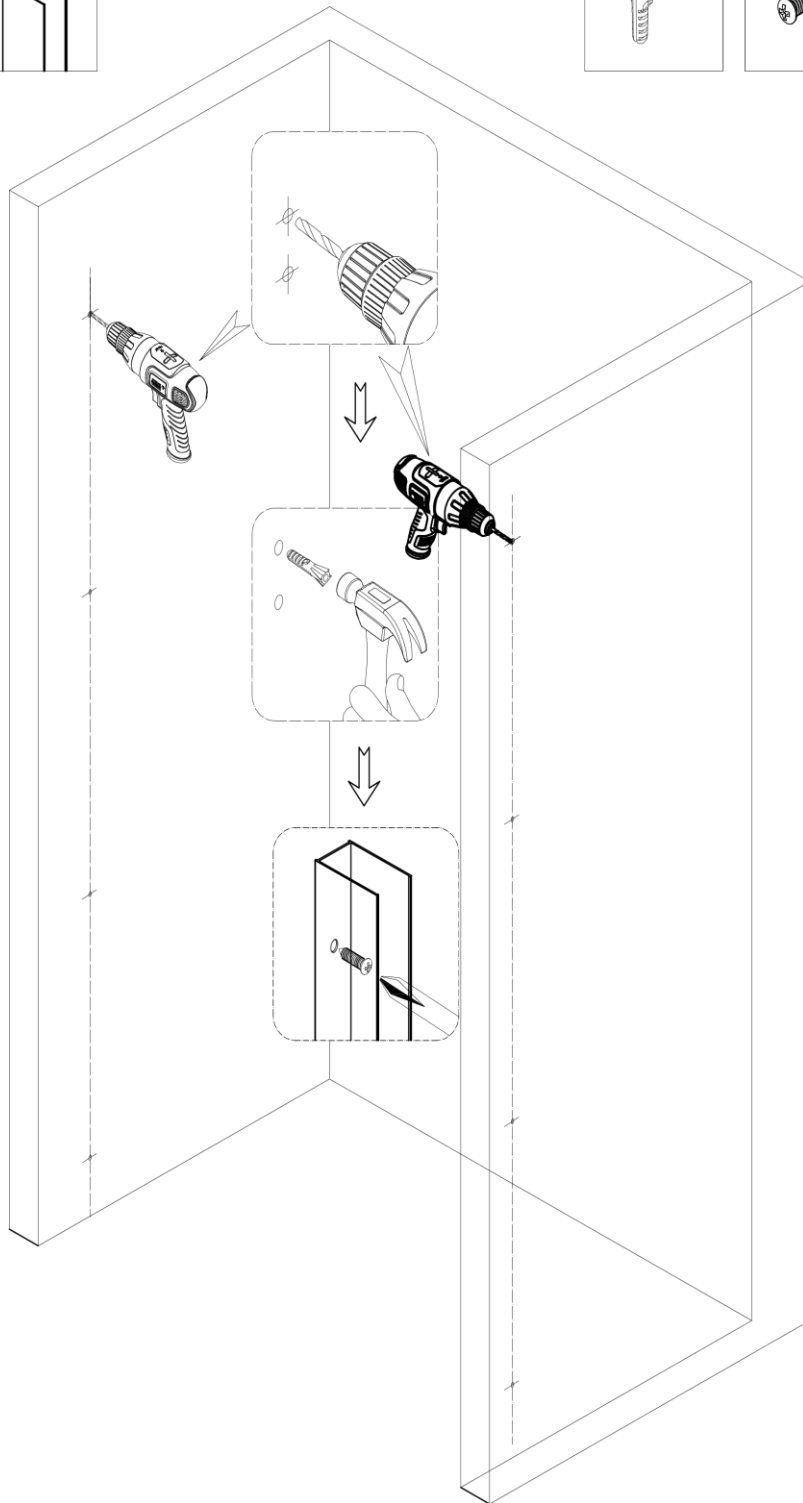
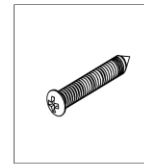
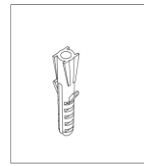
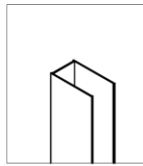

3. Drill holes and insert wall plugs.
4. Screw the aluminium profiles onto each wall.

# Glass door panel assembly

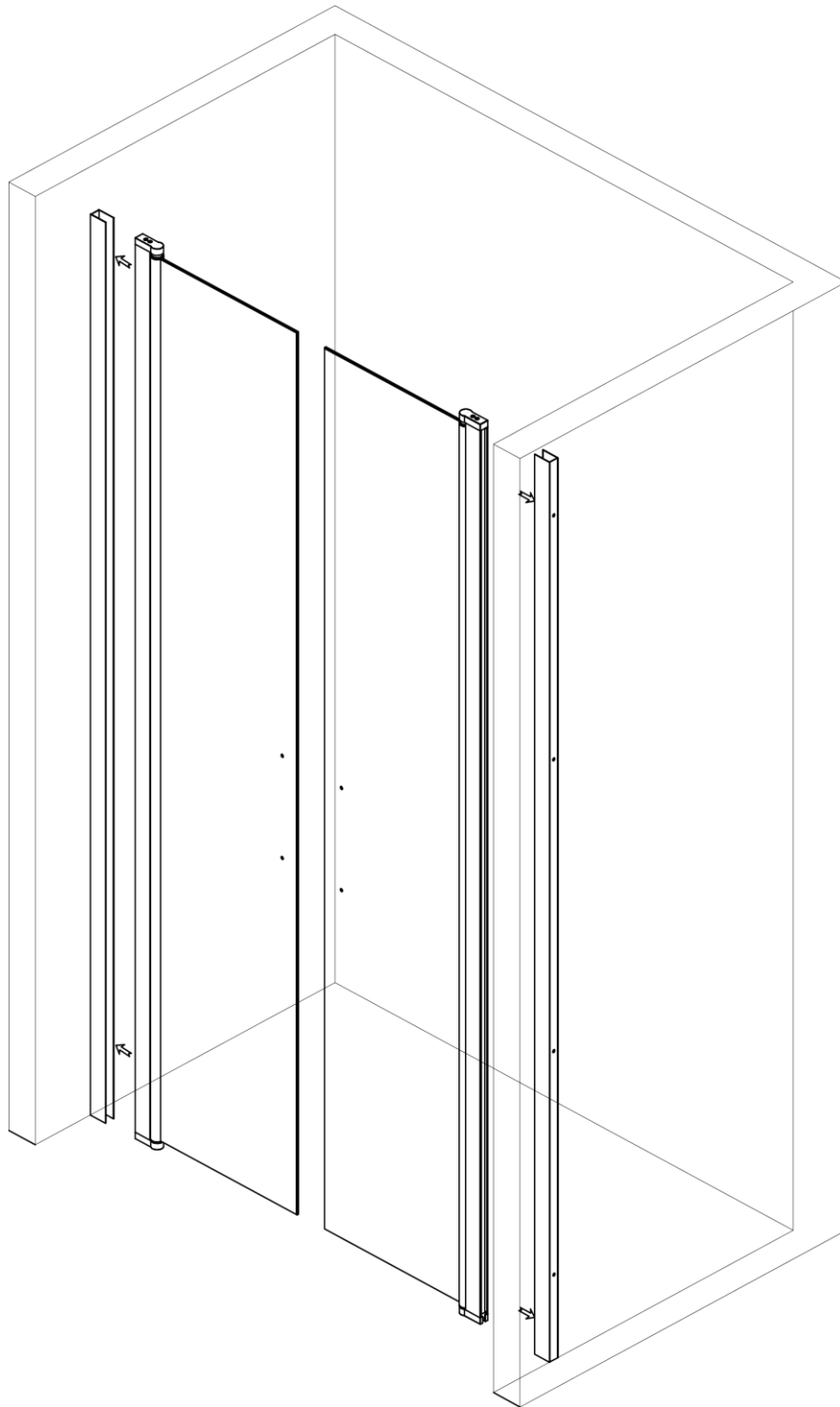

5. Carefully lift the glass doors, sliding them into the aluminium profiles.

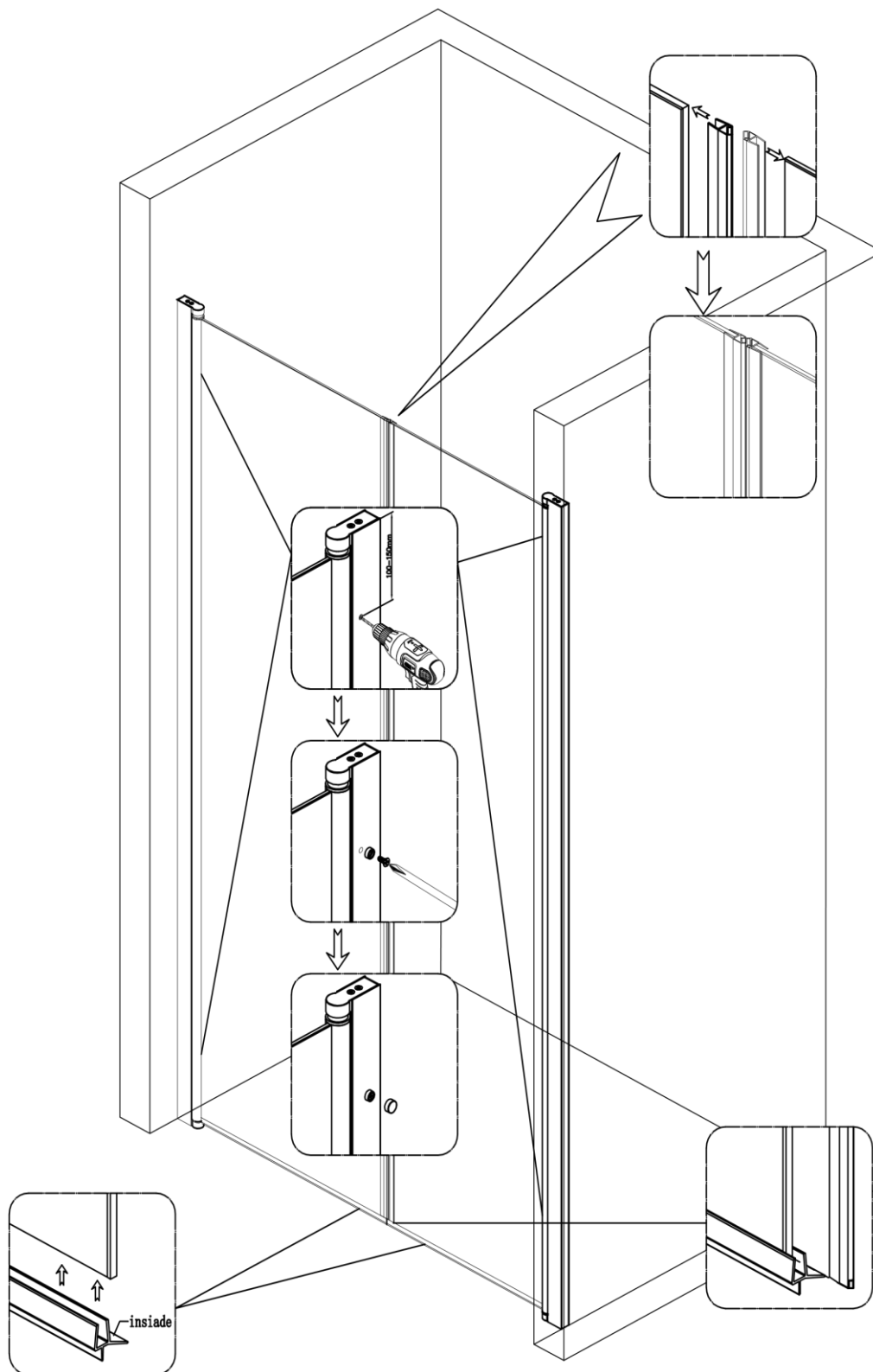

6. Slide seals onto both glass doors.
7. Carefully drill pilot holes into the aluminium profiles, screwing the aluminium profile onto the profile against the glass door, inserting caps over the screws.
8. Slide the bottom seals onto each glass door.



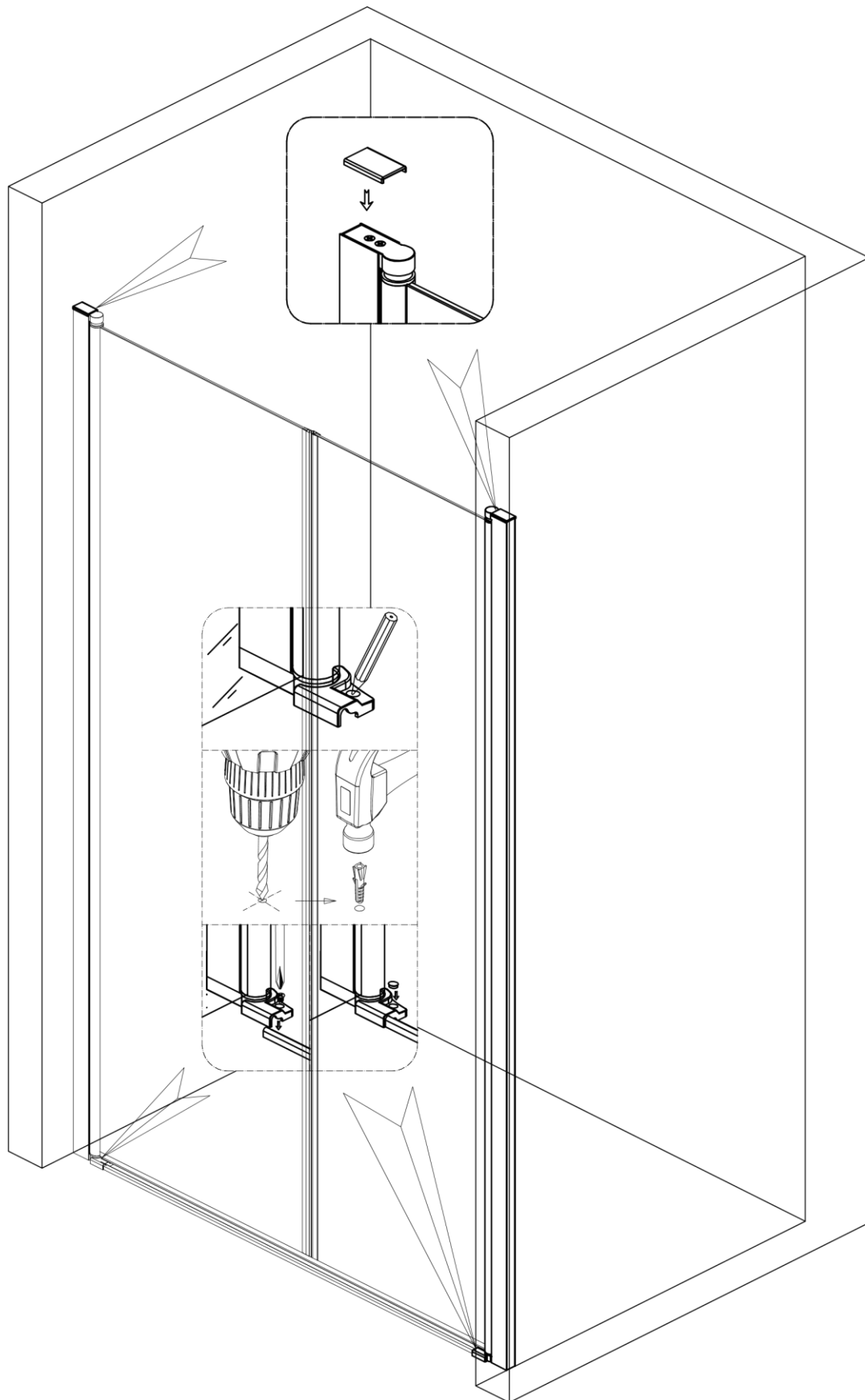

9. Insert caps on top of both aluminium profiles.
10. Slide fixing pieces into place, marking where holes will be drilled.
11. Drill holes and insert plugs, screwing the fixing pieces into place.
12. Attach weather bar to the fixing pieces.

# Apply silicone sealant

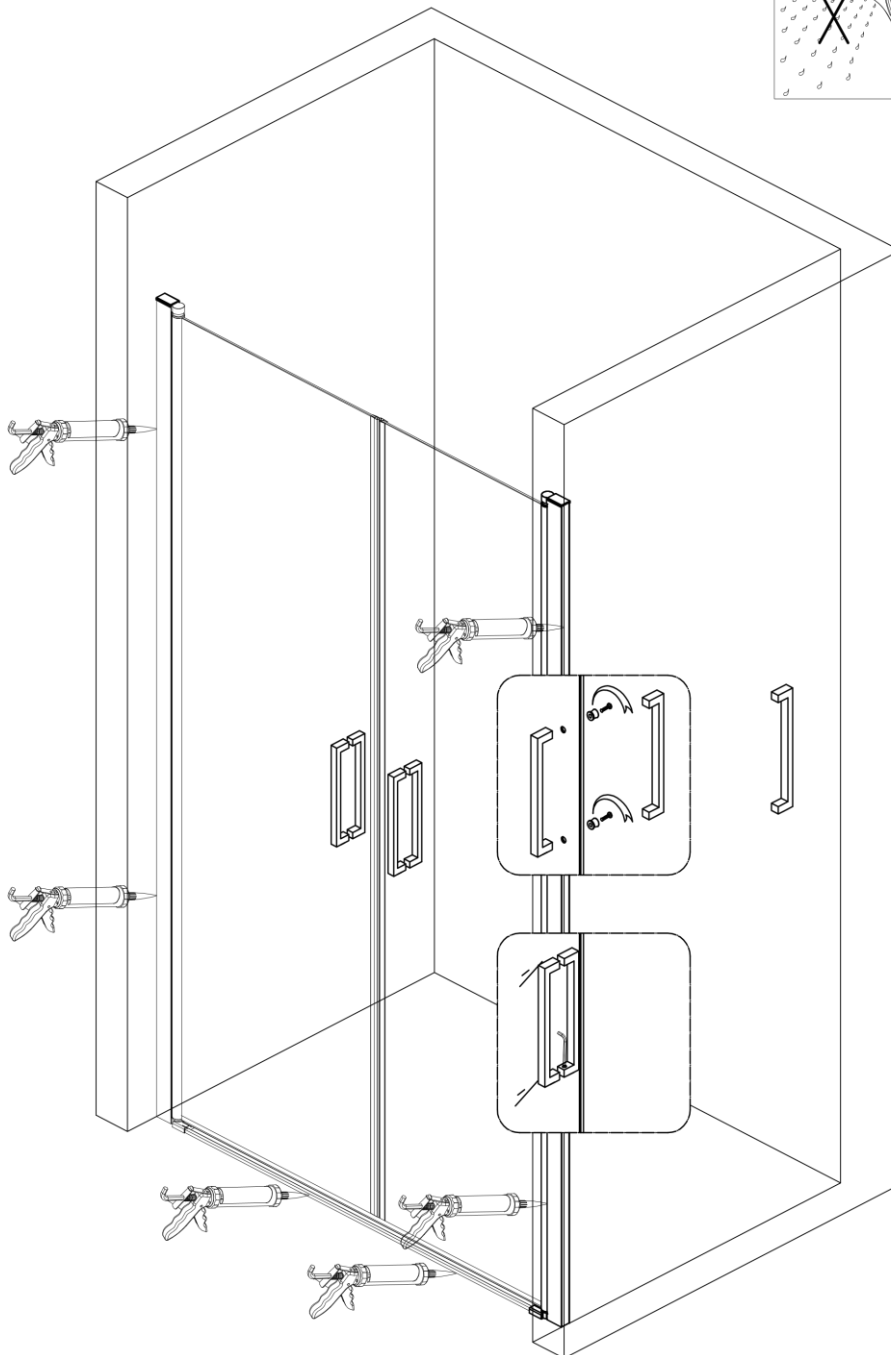
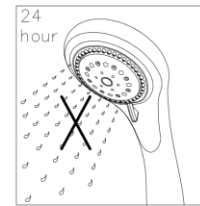

13. Attach the handles to the glass doors.
14. Silicone and allow to dry for 24 hours.