

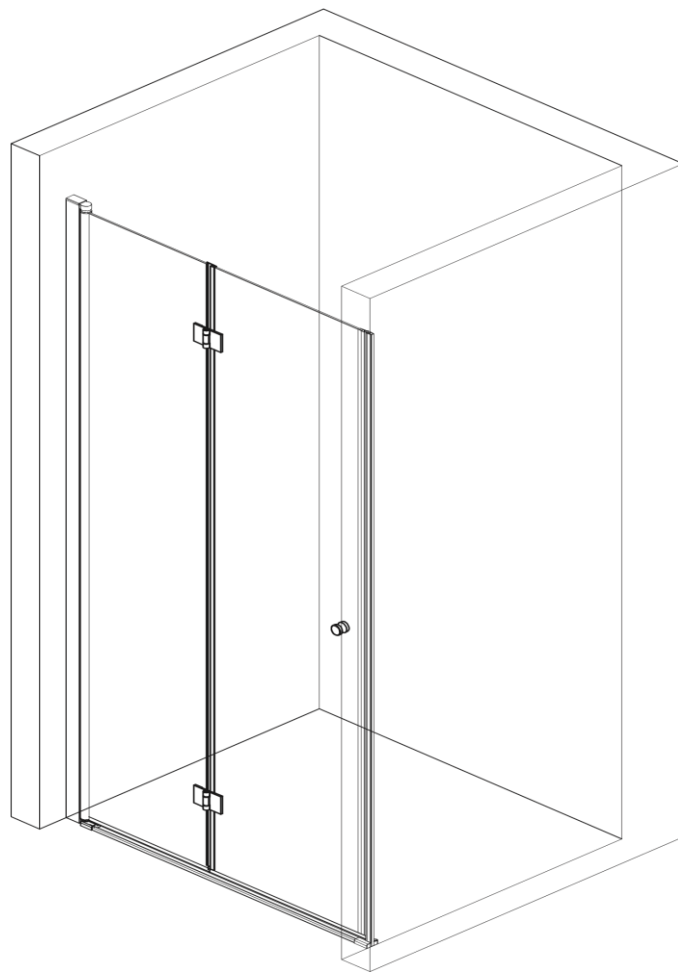

#### IMPORTANT SAFETY NOTES

- Under no circumstances should you attempt to drill through the glass, damage or injury may occur
- Please handle all glass with care, avoiding knocks and shock loading to all sides and edges. Safety glass cannot be reworked.
- Care should be taken when drilling into walls to avoid hidden pipes or electrical cables.



**Ravenna 26 Single Door**

## Tools Required

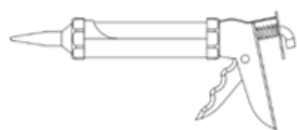

Silicone Gun

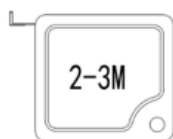

Tape Measure



Scissors

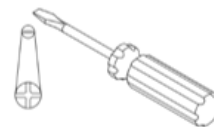

Philips Screwdriver



Hammer



Allen Keys



Drill Bit



Pencil

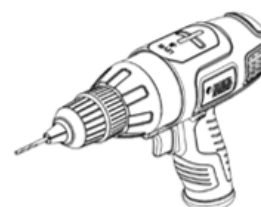

Power Drill



Level

Two people required. We recommend that a technically competent installer should undertake this installation.

Be sure you have all included parts and tools required before beginning installation and that you have plenty of space for assembly.

If you have ordered this shower enclosure with one of our shower trays, **please note** that tiling should be done before the shower tray is installed. This is so that the shower tray can be pushed up against the tiles and sealed with silicone.

### PRE-INSTALLATION AND TECHNICAL REQUIREMENTS









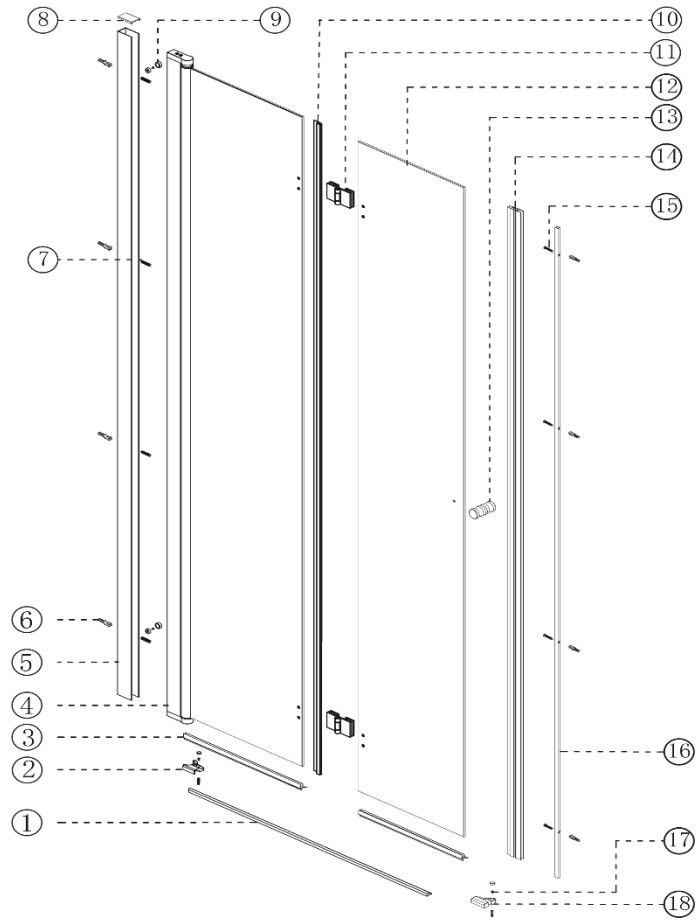









- All dimensions are shown in millimetres, except where otherwise indicated.
- Ensure that the enclosure set is fitted to a level floor and vertical wall surface.
- This instruction manual is applicable for both pre-tiled wall and plain walls.
- The wall fixings included with this product are suitable for solid walls only. Plasterboard or stud walls may require specialist fixings (not supplied).
- Due to the possibility of residual spray, the area around the outside of the shower tray should be tiled, or made otherwise water resistant.

### IMPORTANT SAFETY NOTES

- Under no circumstances should you attempt to drill through the glass, damage or injury may occur
- Please handle all glass with care, avoiding knocks and shock loading to all sides and edges. Safety glass cannot be reworked.
- Care should be taken when drilling into walls to avoid hidden pipes or electrical cables.

# Included Parts



Ref	Description	Illustrations	Qty	Ref	Description	Illustration	Qty
①	Weather Bar		1	⑩	Door Seal		1
②	Fixing Piece		1	⑪	Hinges		2
③	Bottom Seals		2	⑫	Glass Door		1
④	Glass Fixed Piece		1	⑬	Handle		1
⑤	Aluminium Profile		1	⑭	Seal		2
⑥	Wall Plugs		10	⑮	ST4*30		4
⑦	ST4*30		4	⑯	Profile		1
⑧	Cap		1	⑰	ST4*16		4
⑨	Caps		2	⑱	Fixing Piece		1

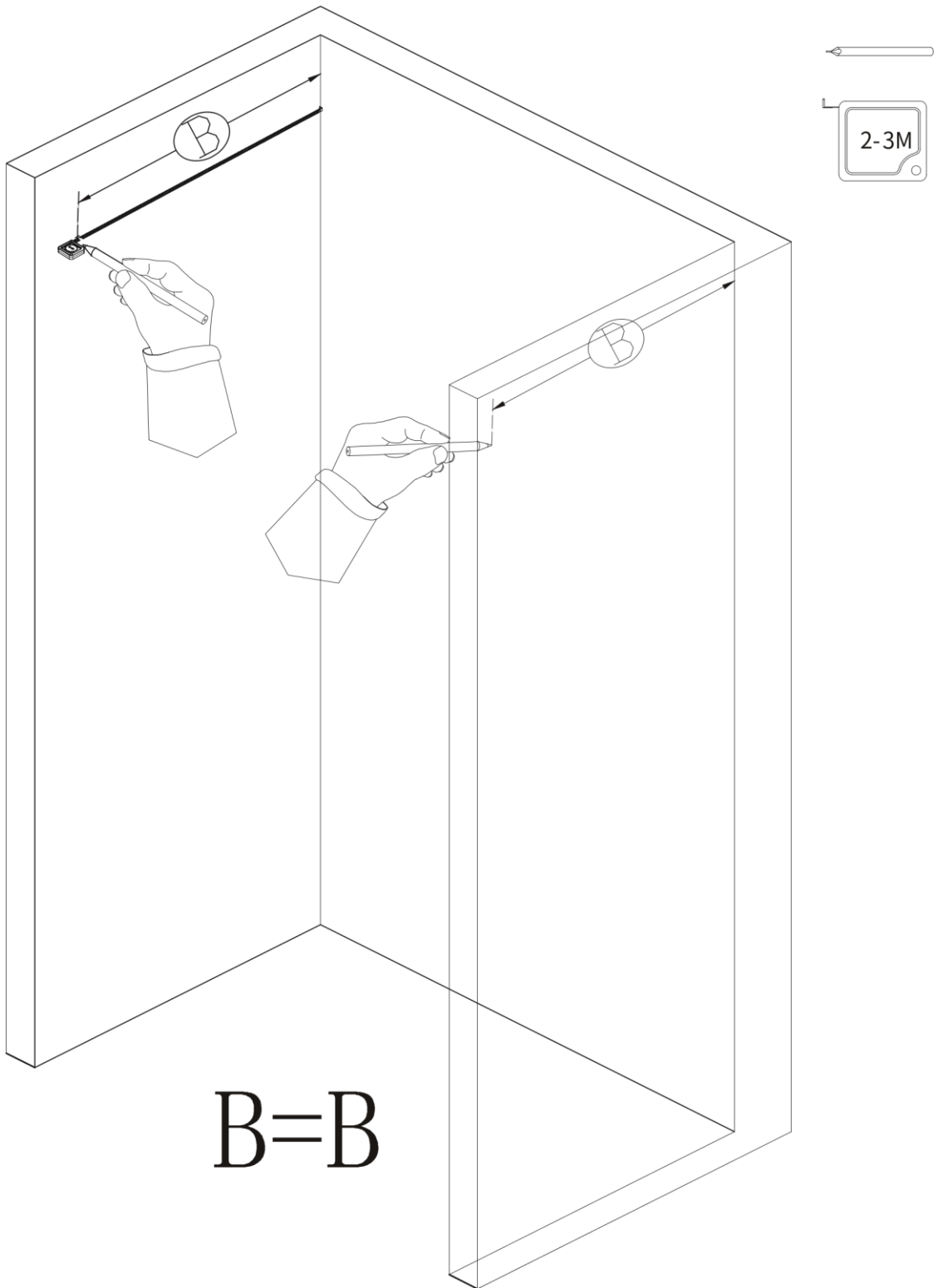

1. Measure where your shower door will be installed.

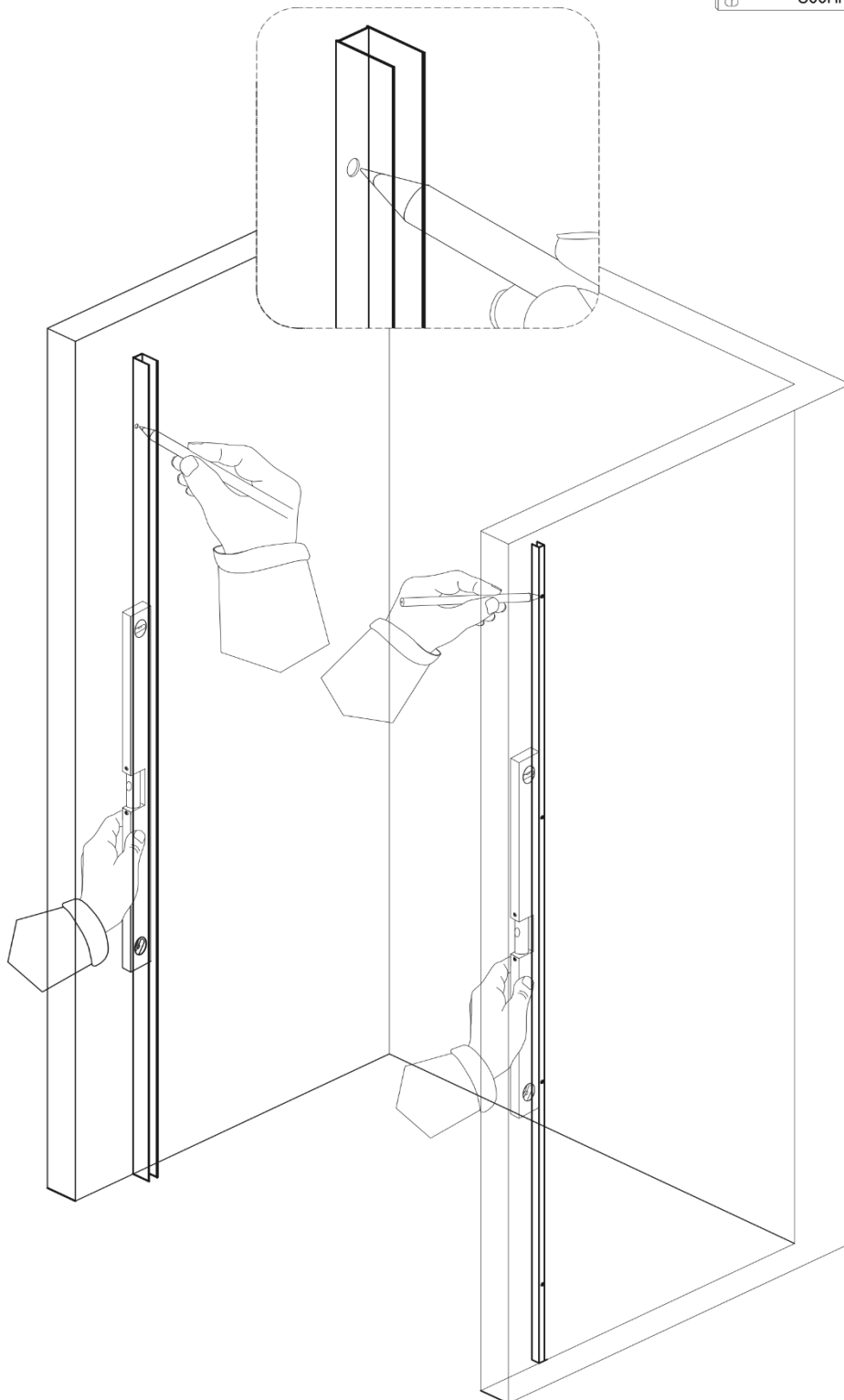

2. Place the aluminium profiles against the walls, marking where holes will be drilled.

06



X10

07

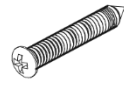

ST4X30

X4

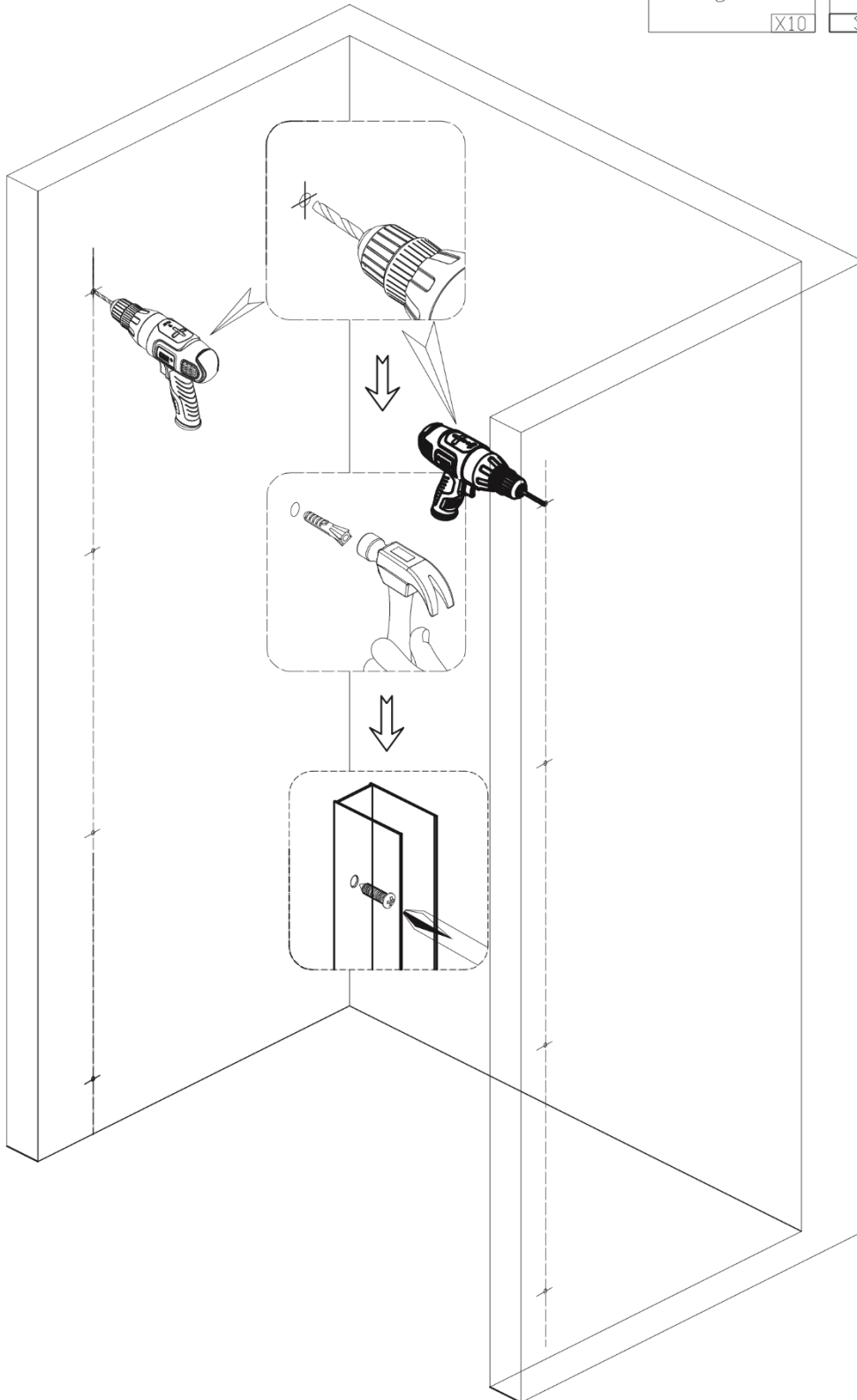

3. Drill holes and insert wall plugs.

4. Screw the aluminium profiles onto the walls.

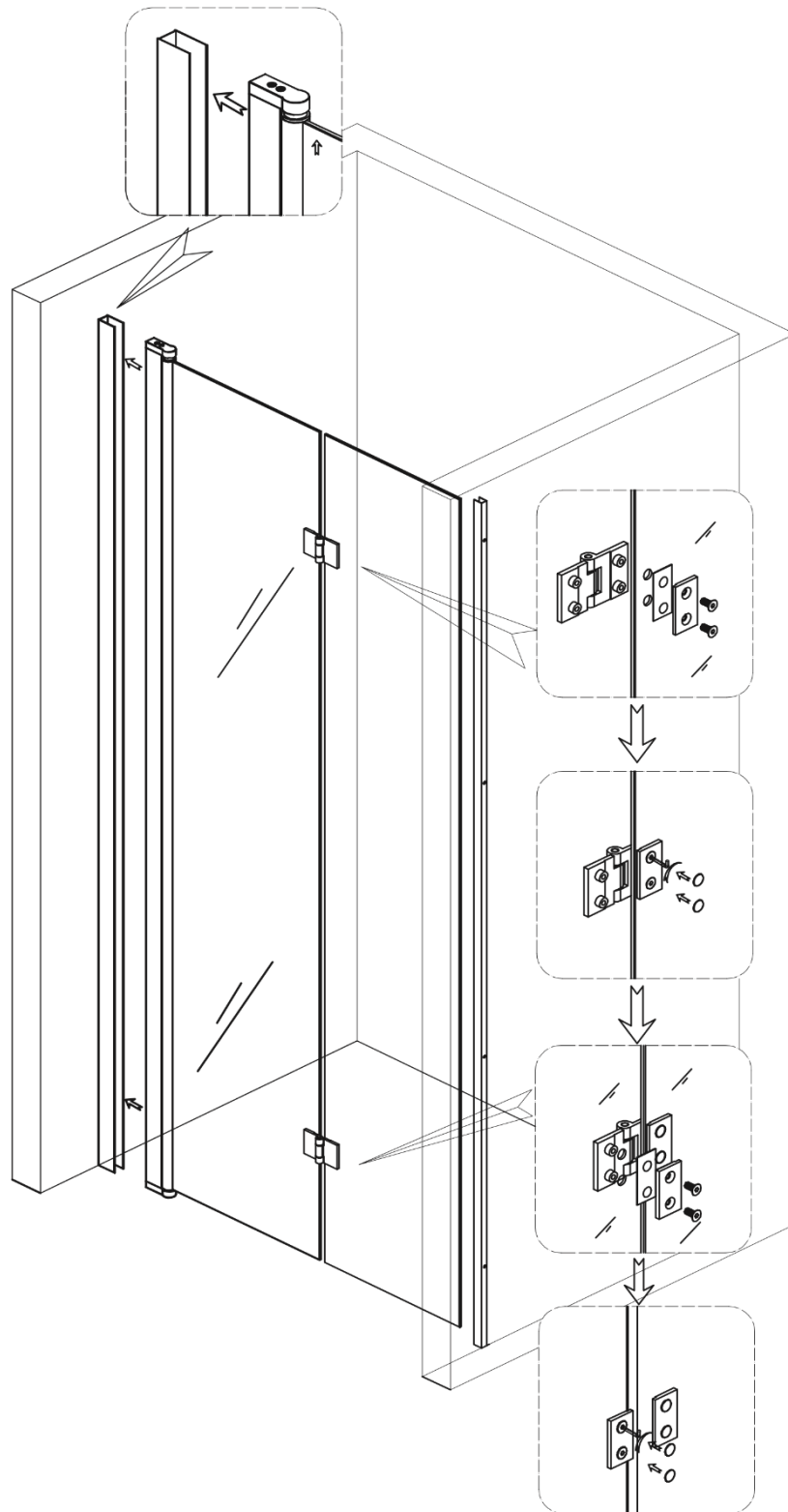

5. Insert the glass fixed panel into the aluminium profile.

6. Attach the glass door to the glass fixed panel with the hinges.

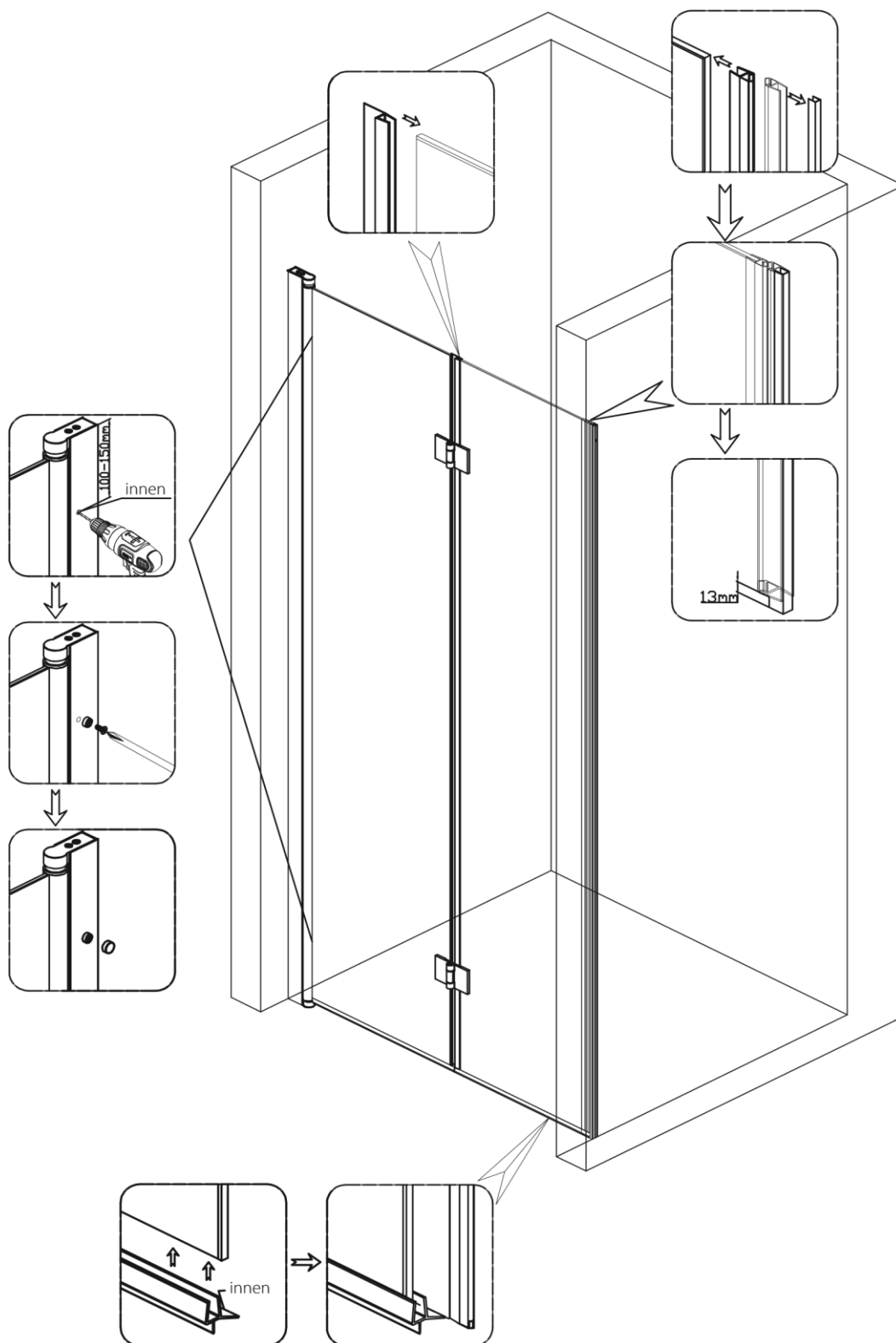

7. Drill pilot holes into the aluminium profile, screwing it to the fixed panel.
8. Insert caps over the holes.
9. Slide side seals onto the glass door.



10. Slide the bottom seals on the door and panel.

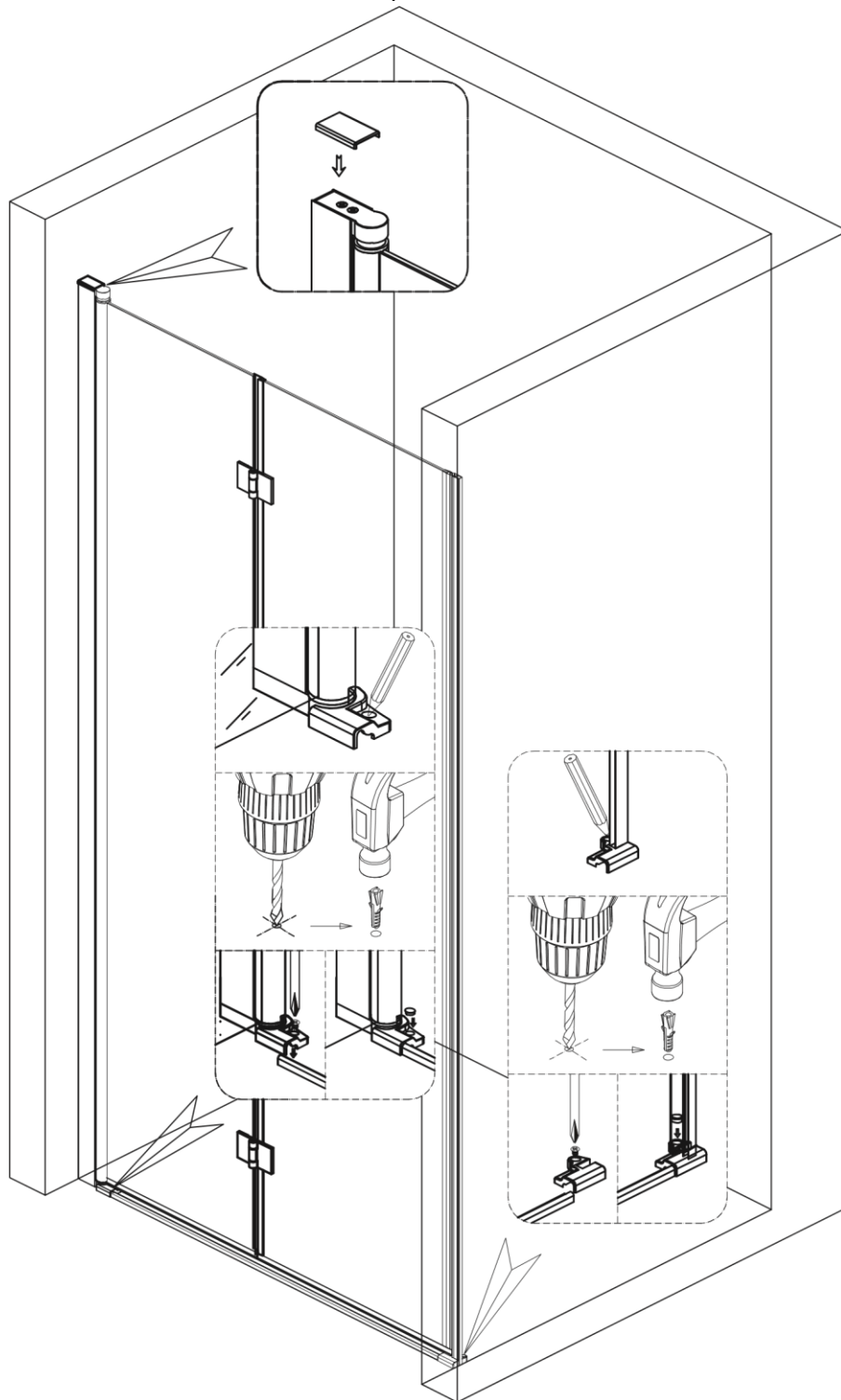

11. Position the fixing pieces, marking where holes will be drilled.

12. Drill holes and insert plugs.

13. Position the weather bar and screw the fixing pieces into position.

14. Insert the cap on top of the aluminium profile.

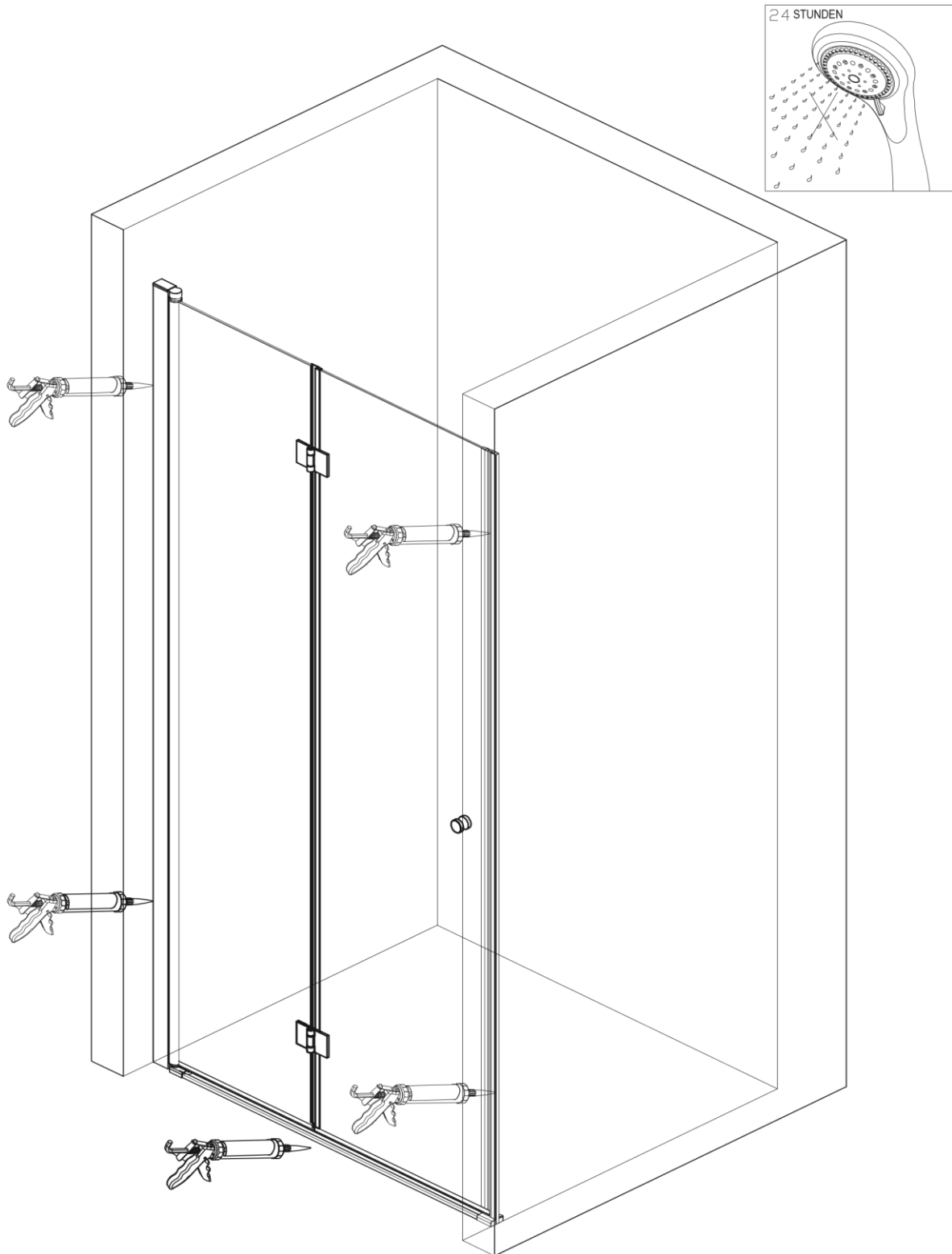

15. Attach the handle.

16. Silicone and allow to dry for 24 hours.