

Ravenna56

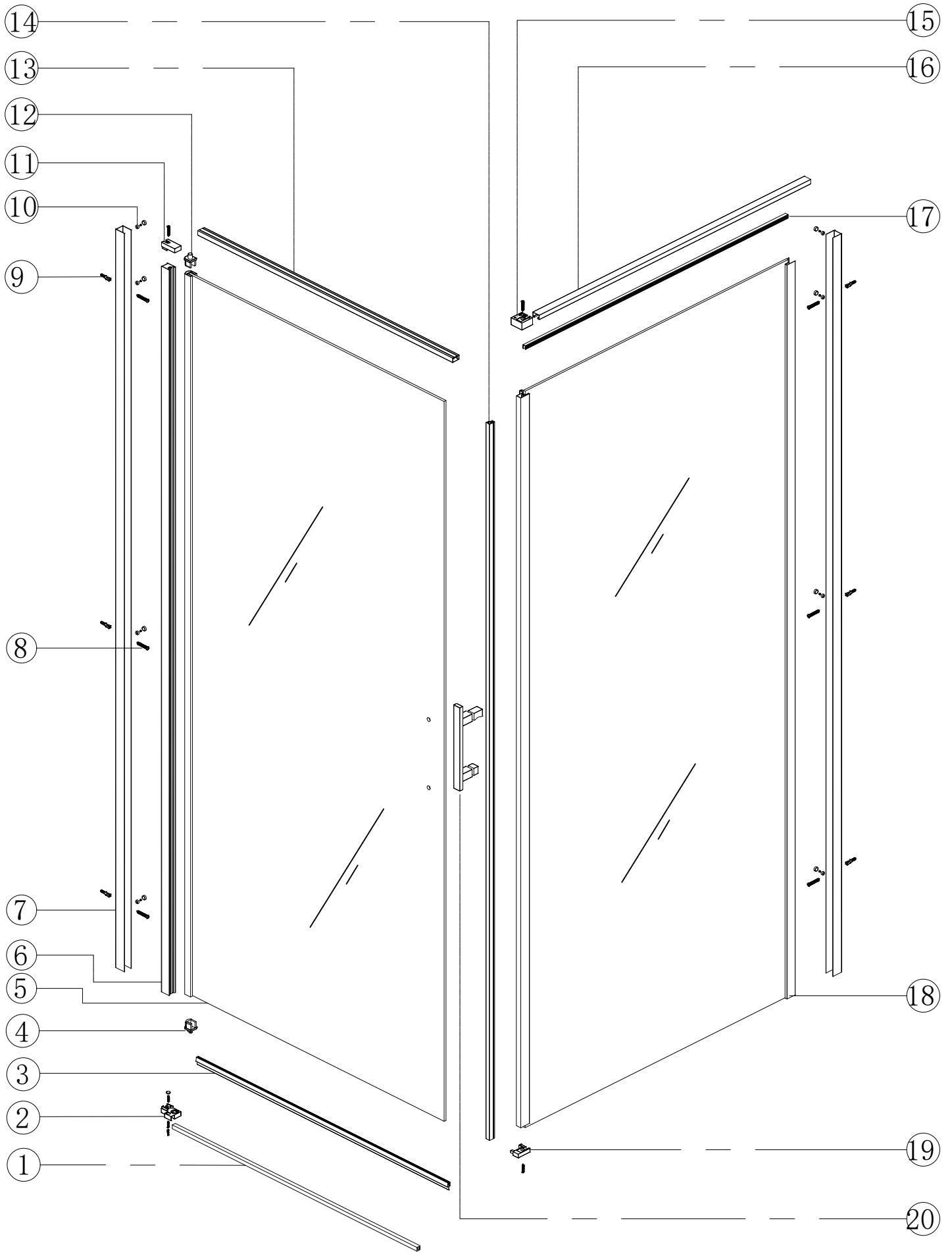

Required tools

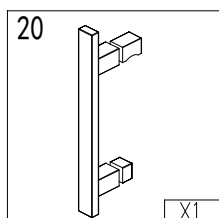

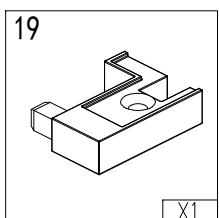
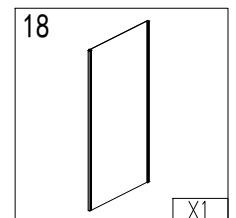
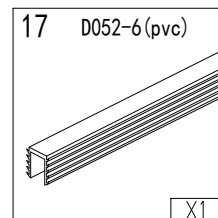
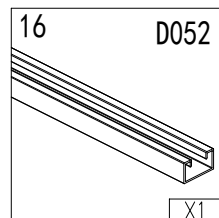
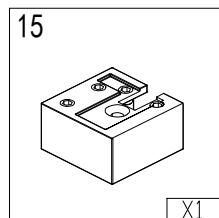
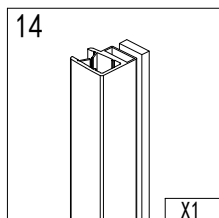
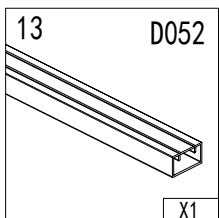
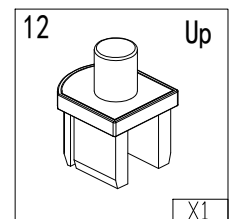
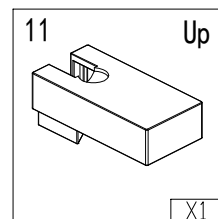
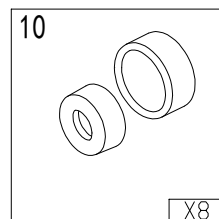
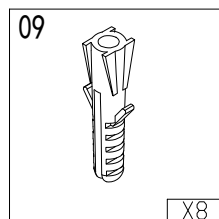
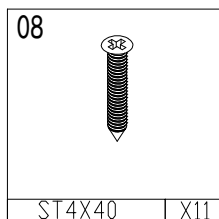
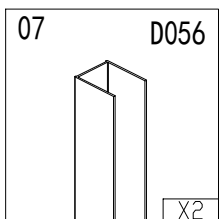
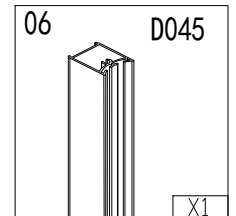
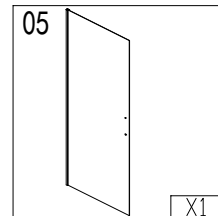
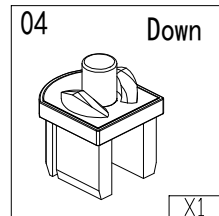
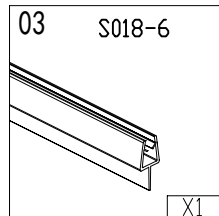
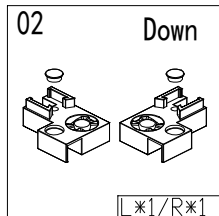
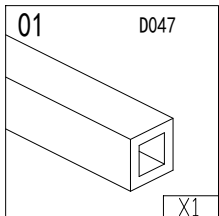
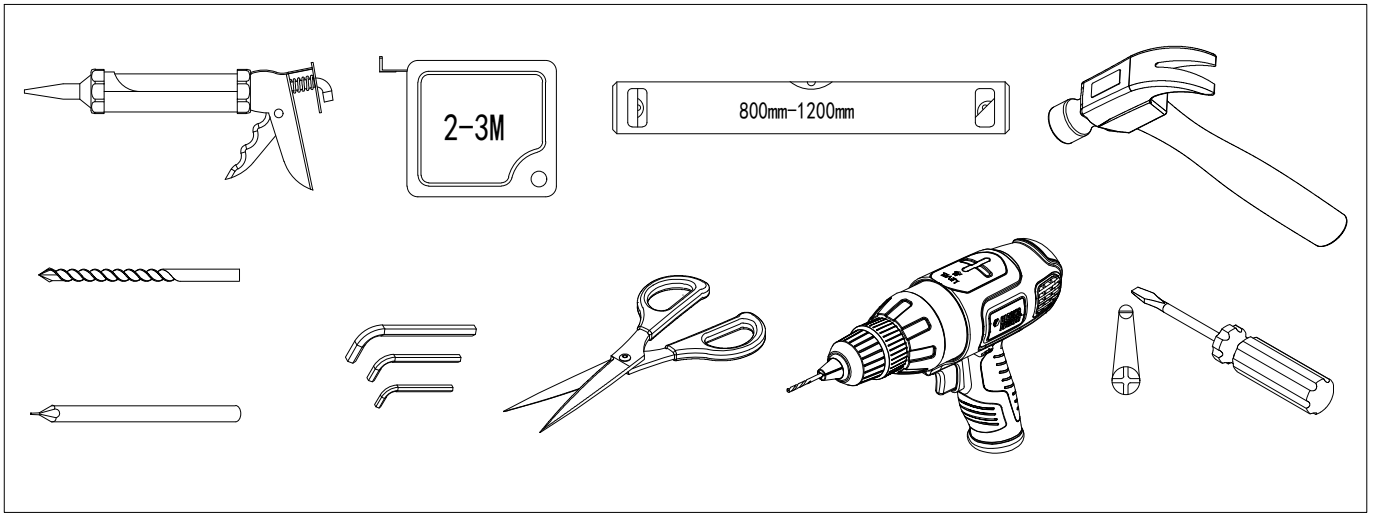
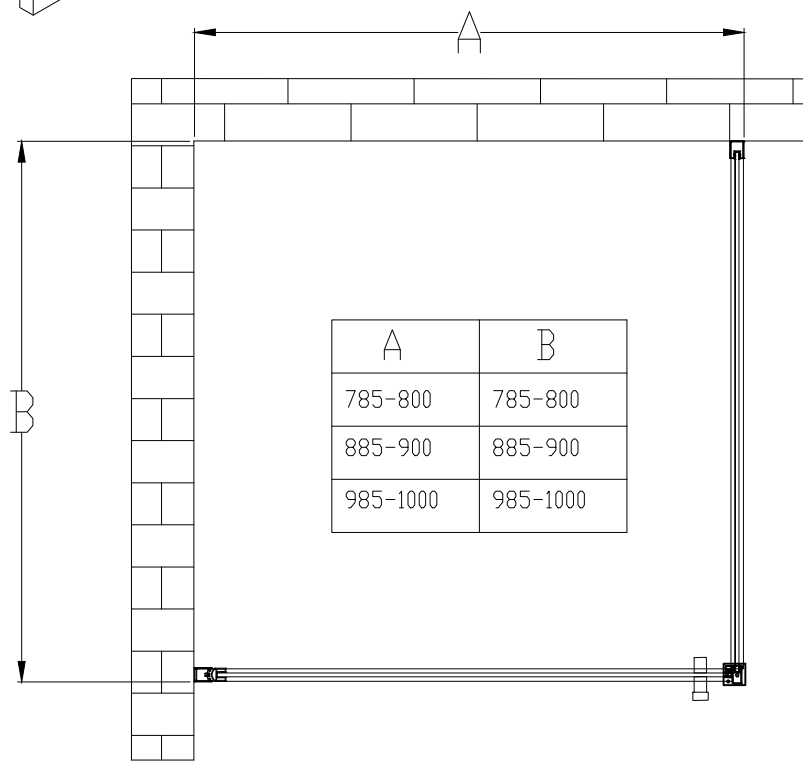
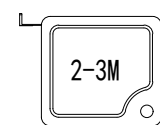
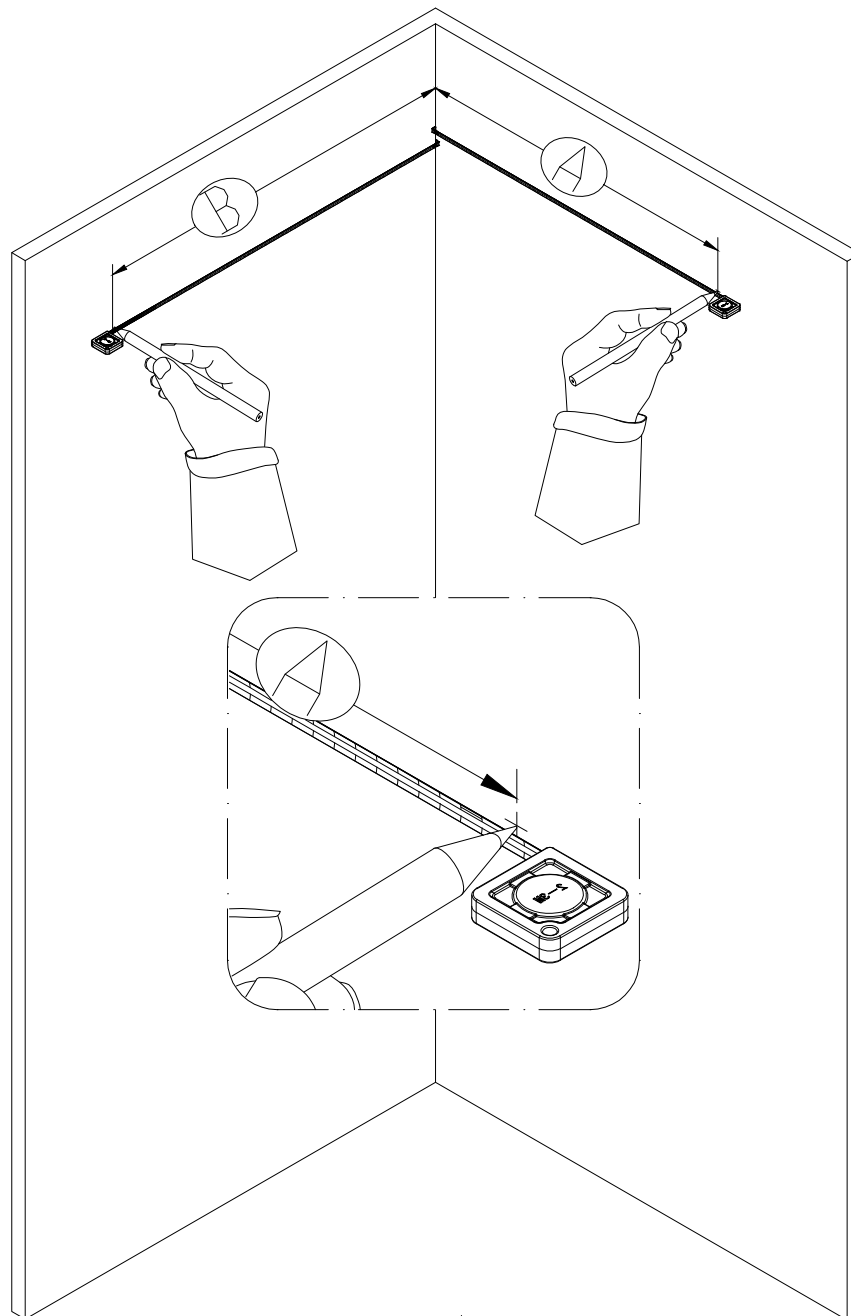

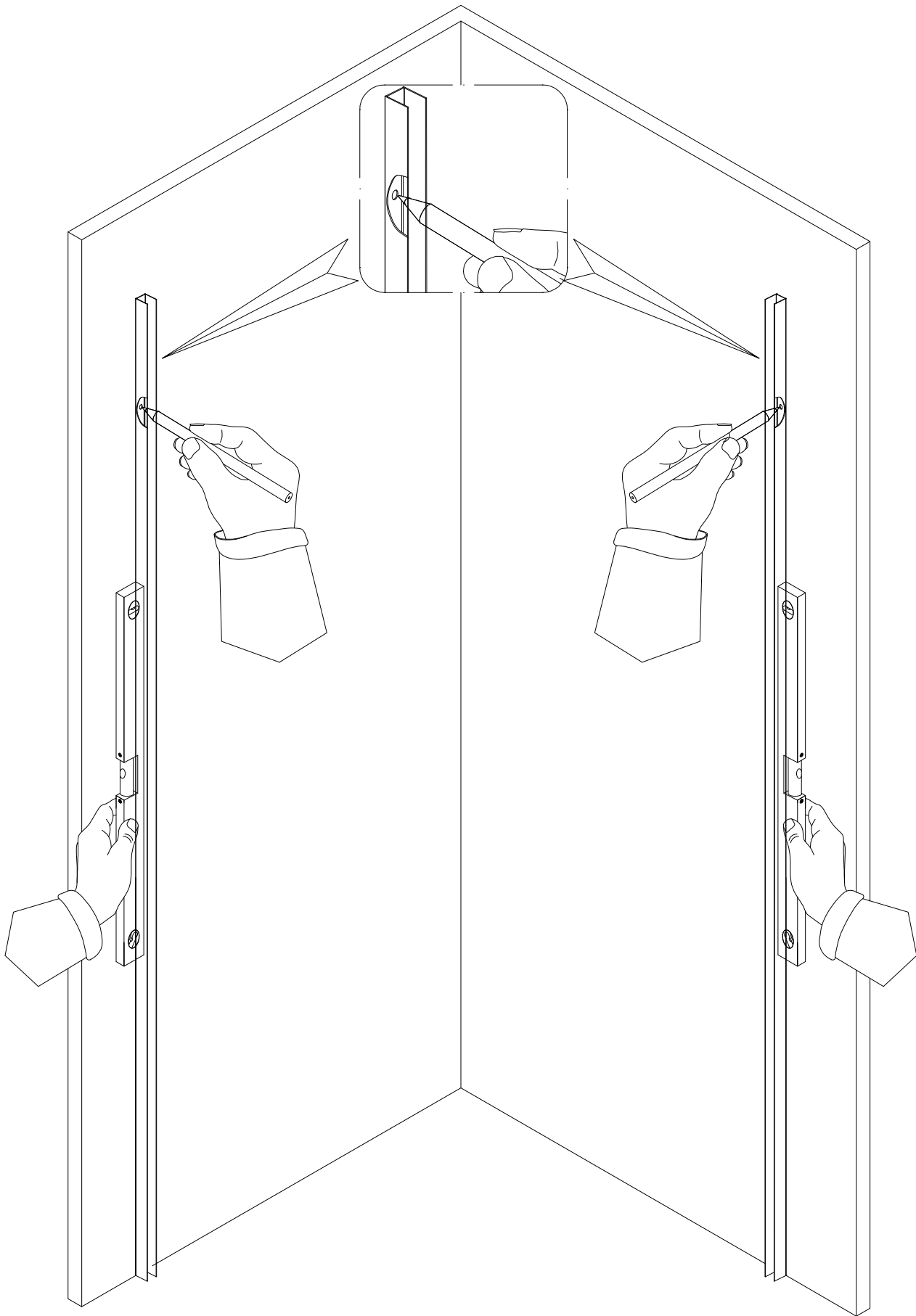

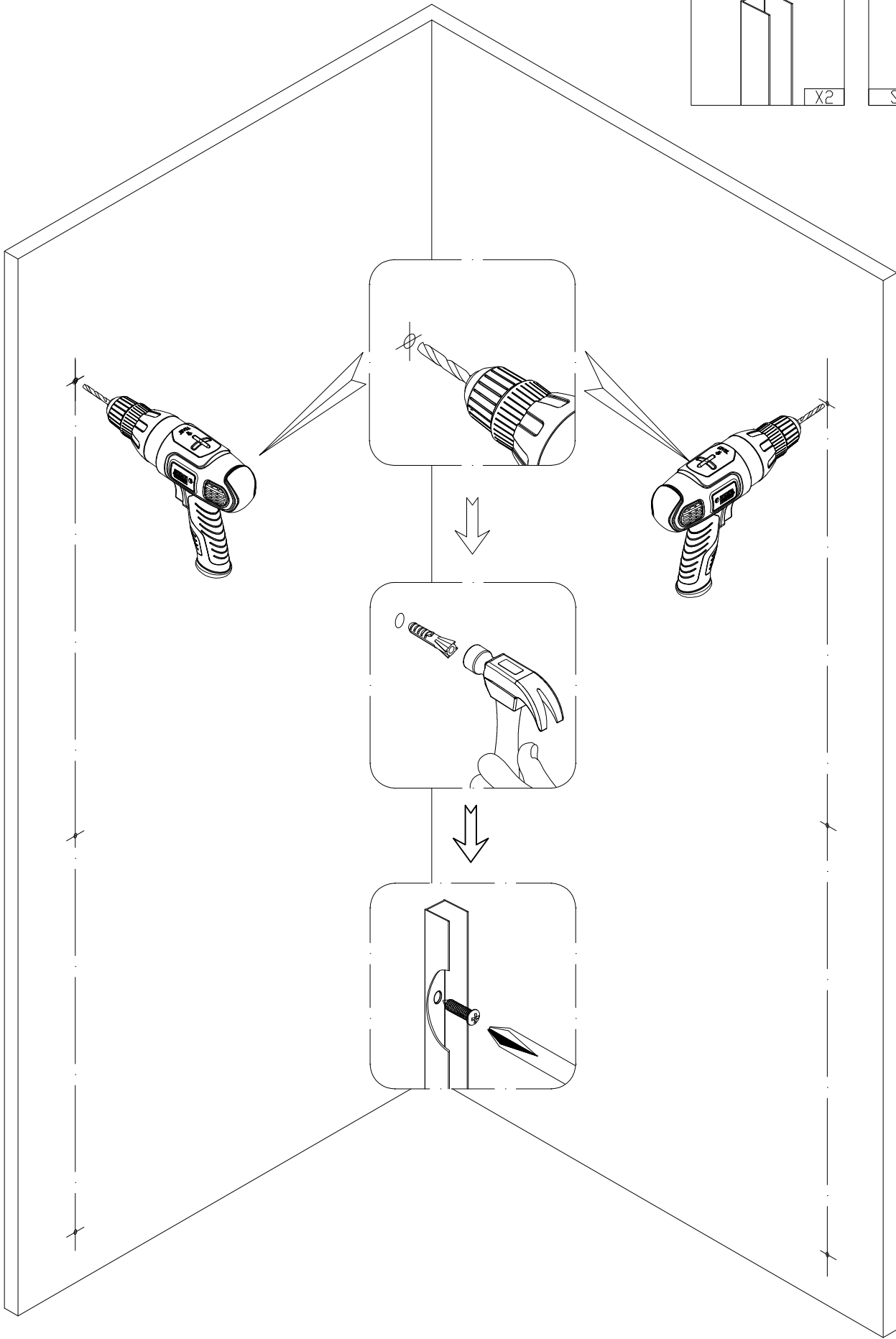
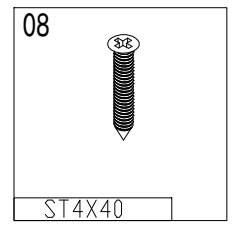
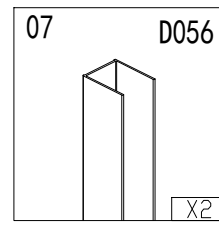

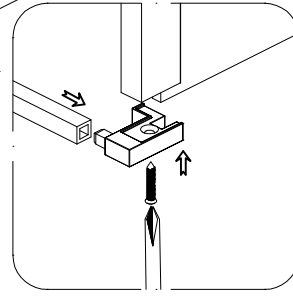
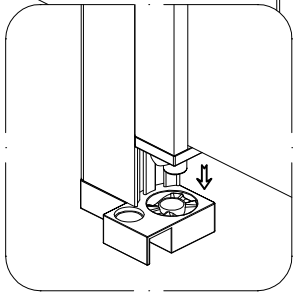
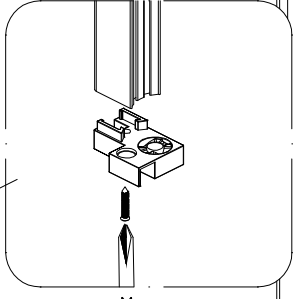
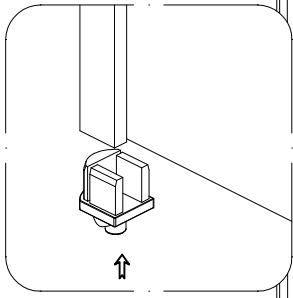
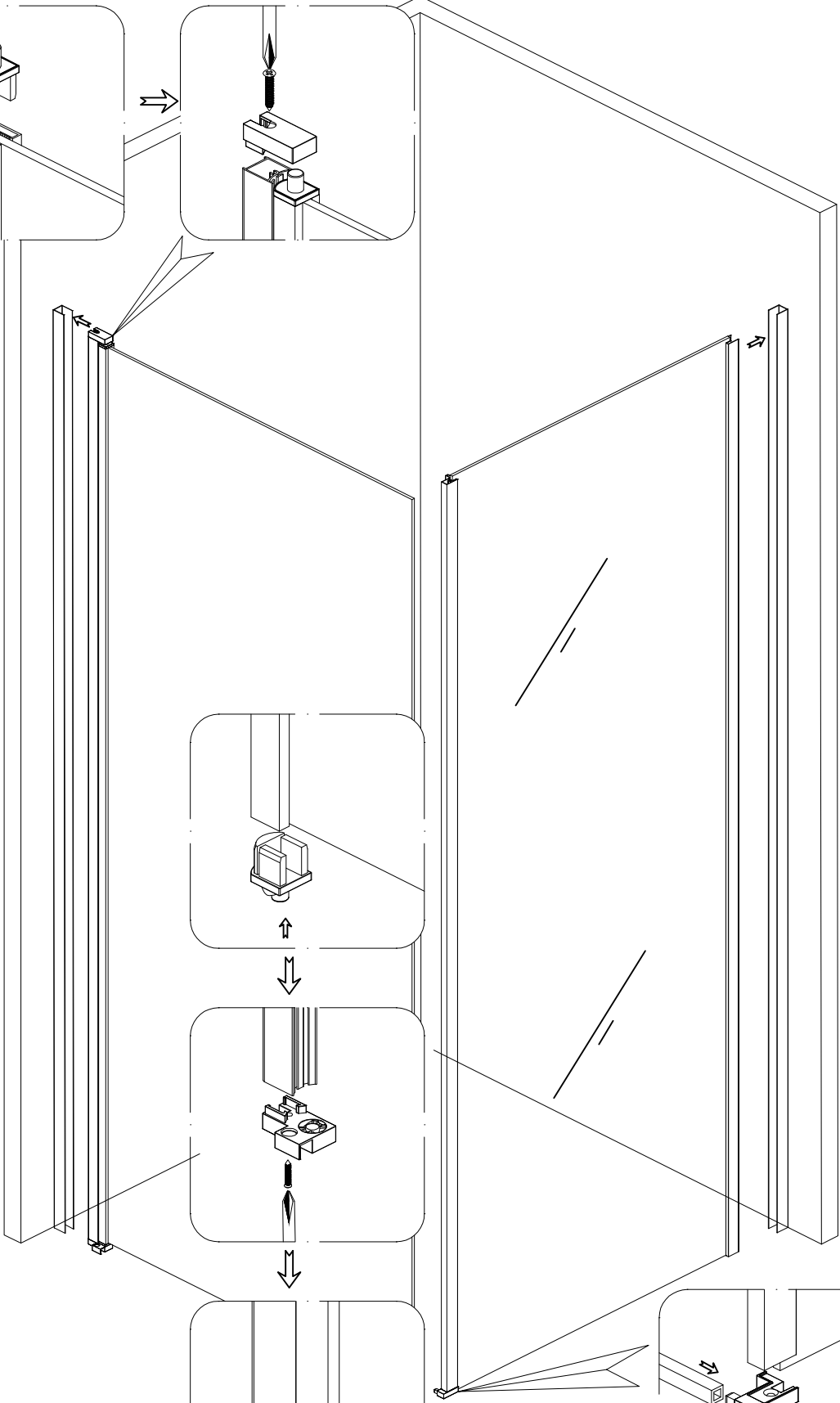
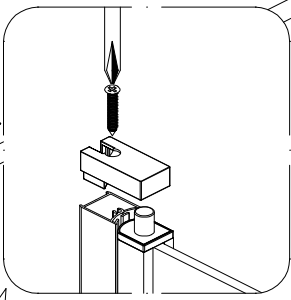
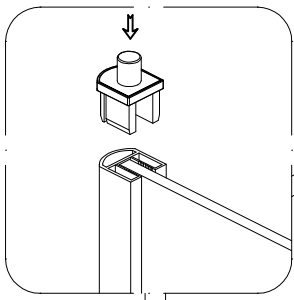
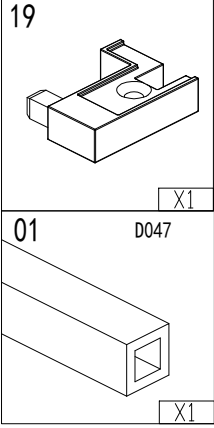
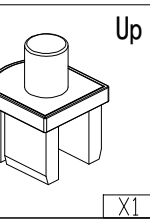
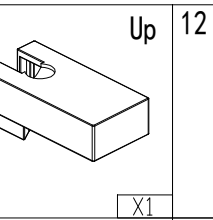
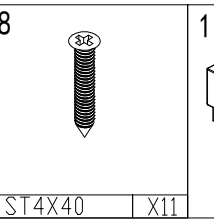
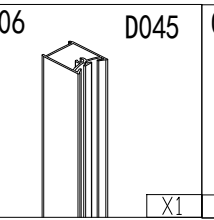
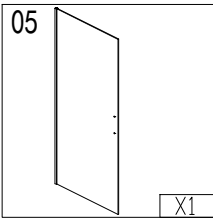
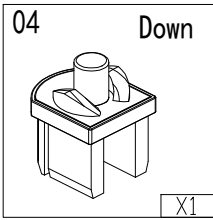
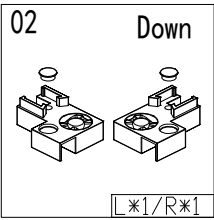

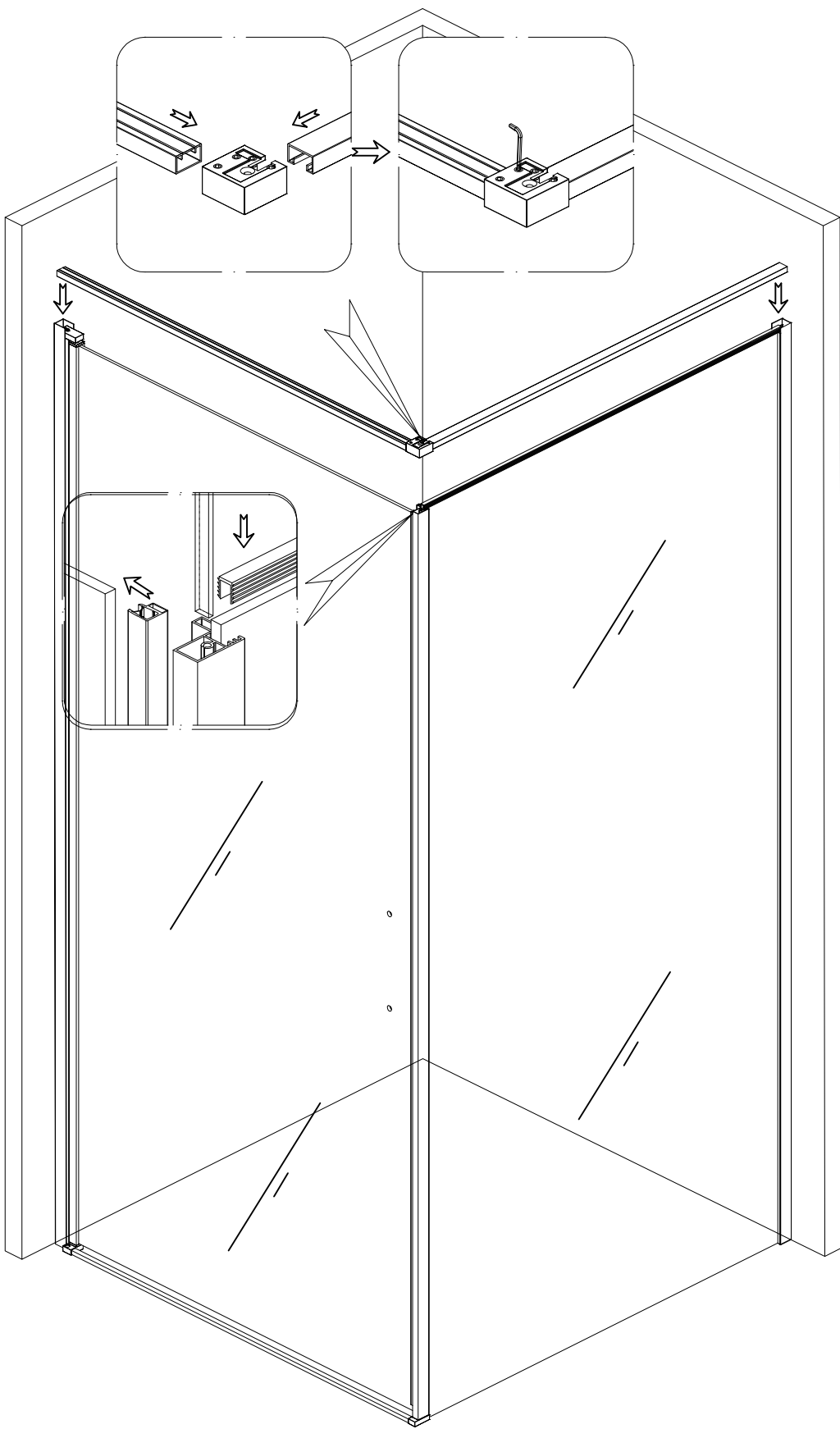
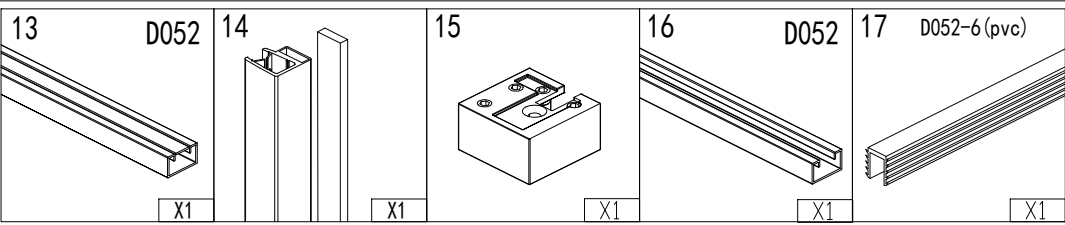

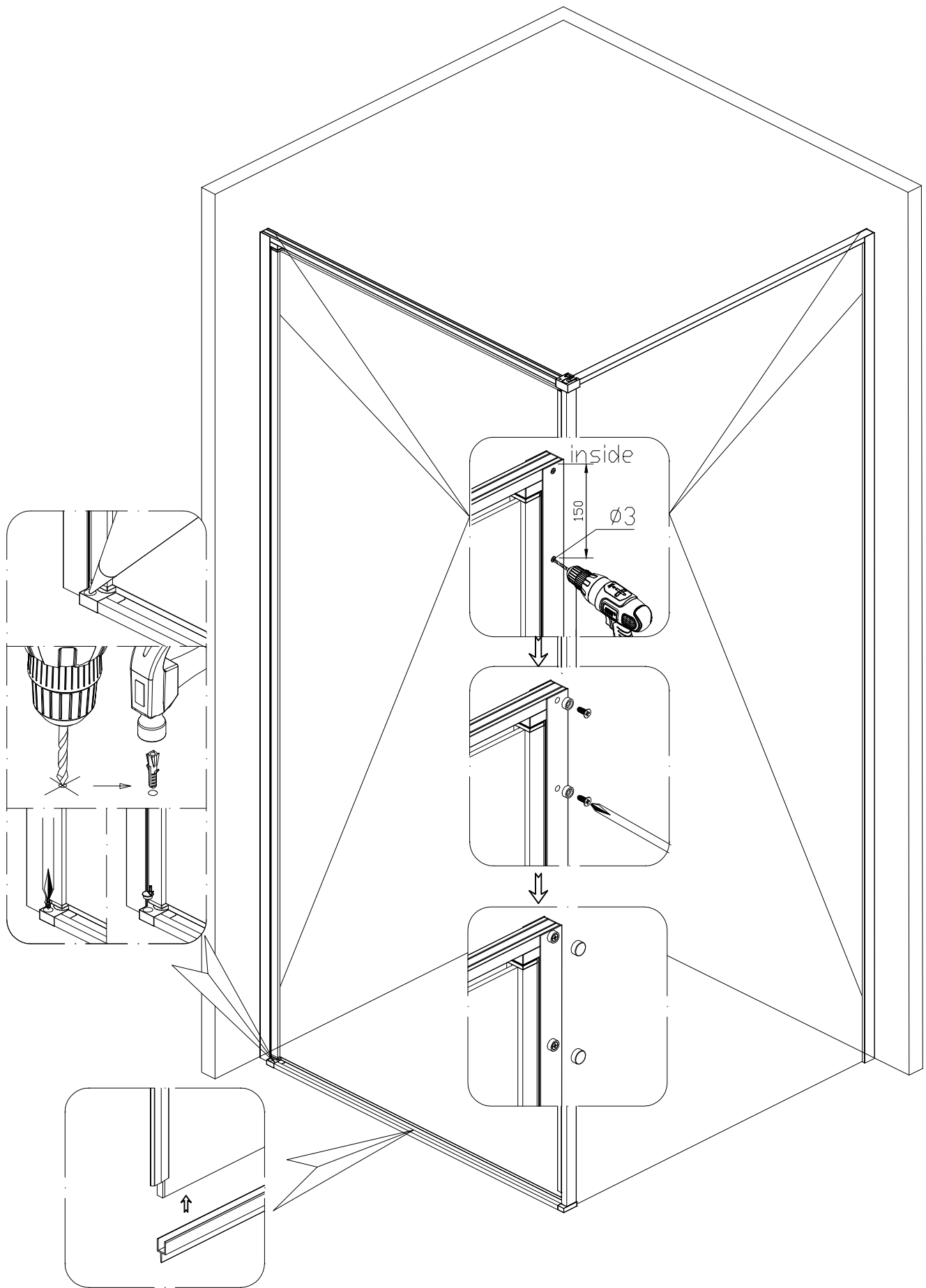

24 hour

