

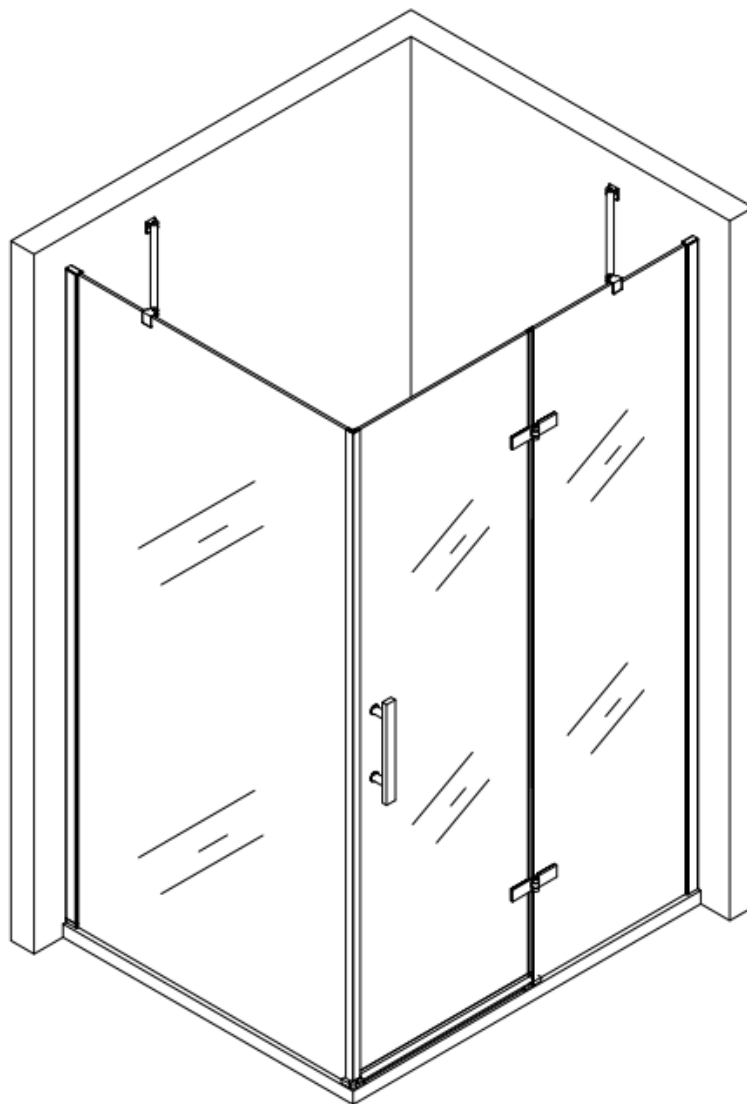

DUROVIN
BATHROOMS



Ravenna 28

Included Parts

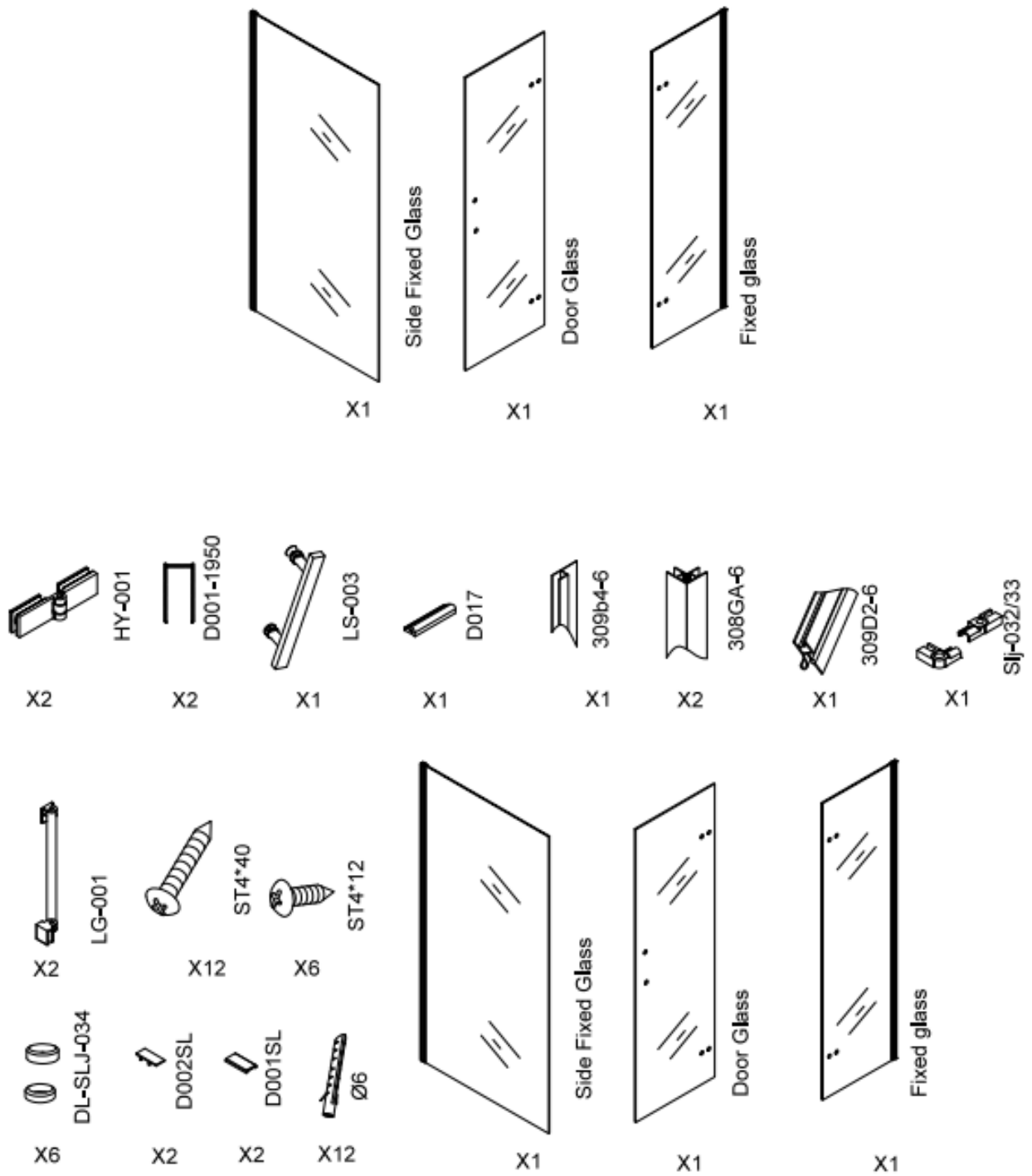

HY-001 x2



Slj-032/33 x1



D002SL x2



D001SL x2



ST4*40 x12



ST4*12 x6



Ø6 x12



LG-001 x2

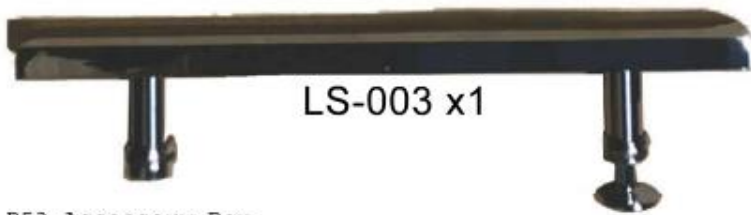

LS-003 x1



DL-SLJ-034 x6

B53 Accessory Box



D001-1950 x2



309b4-6 x1



308GA-6 x1



309D2-6 x1



D017 x1 x1



B93 Accessory Box

Tools Required

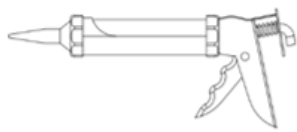

Silicone Gun

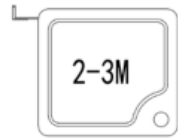

Tape Measure



Scissors

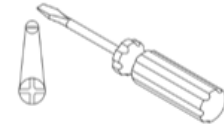

Philips Screwdriver



Hammer



Allen Keys

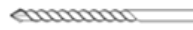

Drill Bit



Pencil



Power Drill



Level

Two people required. We recommend that a technically competent installer should undertake this installation.

Be sure you have all included parts and tools required before beginning installation and that you have plenty of space for assembly.

If you have ordered this shower enclosure with one of our shower trays, **please note** that tiling should be done before the shower tray is installed. This is so that the shower tray can be pushed up against the tiles and sealed with silicone.

PRE-INSTALLATION AND TECHNICAL REQUIREMENTS

- All dimensions are shown in millimetres, except where otherwise indicated.
- Ensure that the enclosure set is fitted to a level floor and vertical wall surface.
- This instruction manual is applicable for both pre-tiled wall and plain walls.
- The wall fixings included with this product are suitable for solid walls only. Plasterboard or stud walls may require specialist fixings (not supplied).
- Due to the possibility of residual spray, the area around the outside of the shower tray should be tiled, or made otherwise water resistant.

IMPORTANT SAFETY NOTES

- Under no circumstances should you attempt to drill through the glass, damage or injury may occur
- Please handle all glass with care, avoiding knocks and shock loading to all sides and edges. Safety glass cannot be reworked.
- Care should be taken when drilling into walls to avoid hidden pipes or electrical cables.

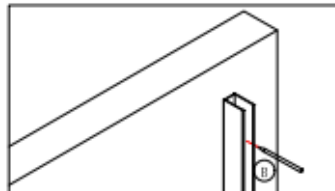
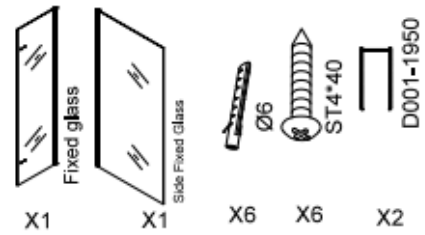
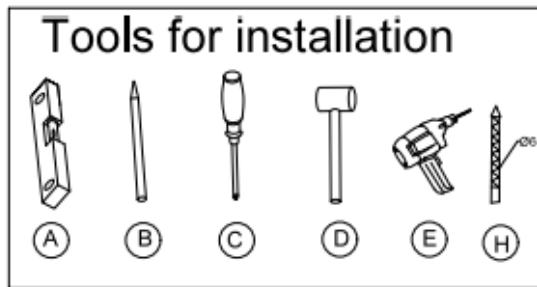

Wall Aluminum Bar

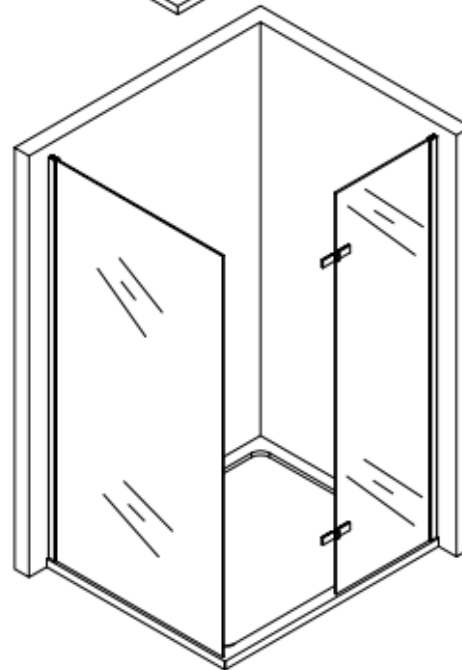
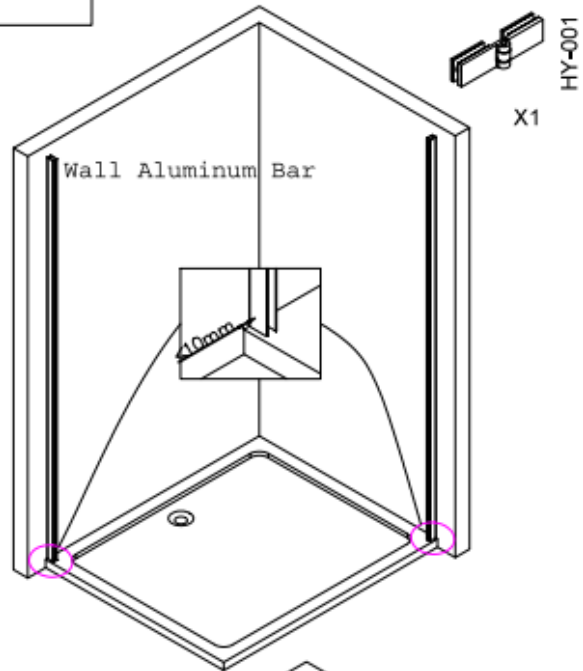
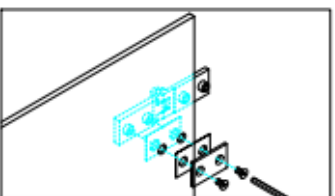
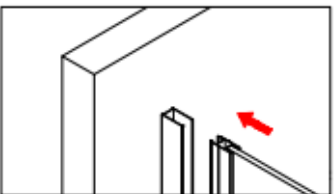
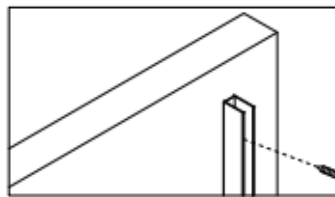
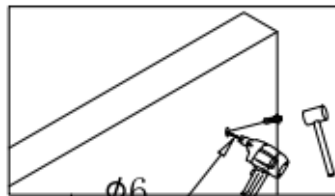

1. Place the aluminium bars against each wall, marking where holes will be drilled.
2. Drill holes and insert wall plugs, screwing the aluminium bars onto each wall.
3. Carefully lift each glass side panel into position.
4. Attach the hinges to the glass side panel.

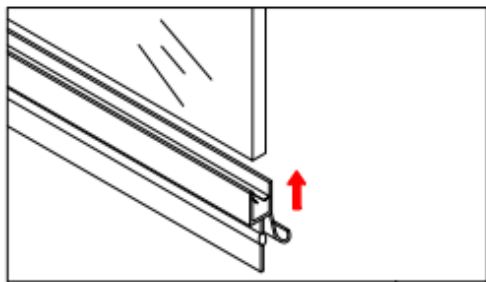
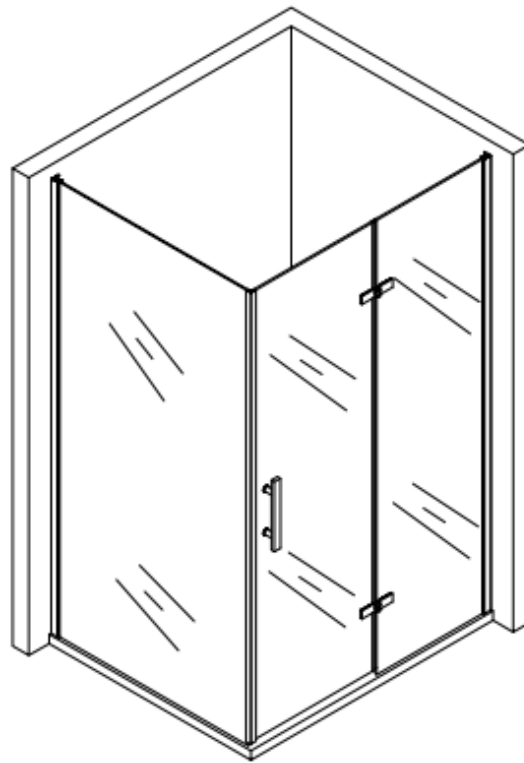
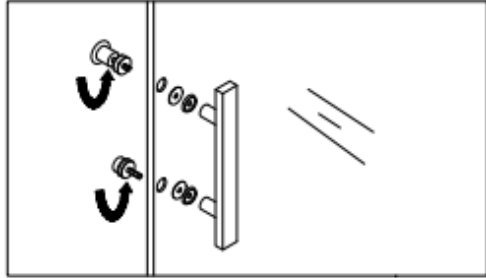
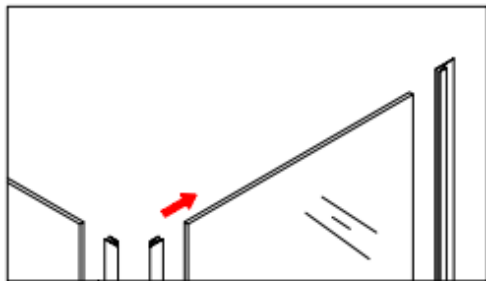
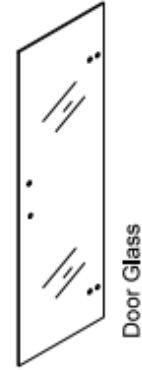
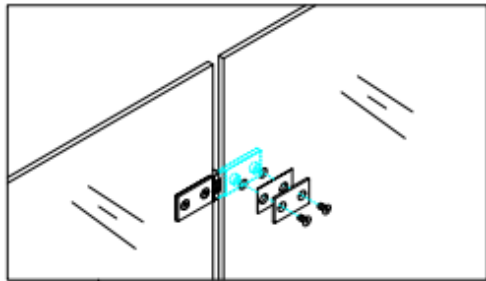
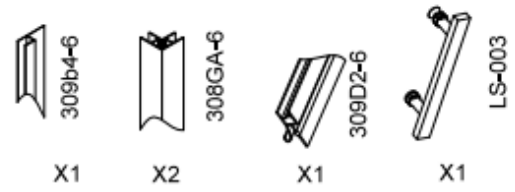

5. Carefully lift the glass door into position, attaching it to the hinges.
6. Slide the water seals onto the glass door and glass side panels.
7. Attach the handle to the glass door.
8. Slide the bottom seal onto the glass door.

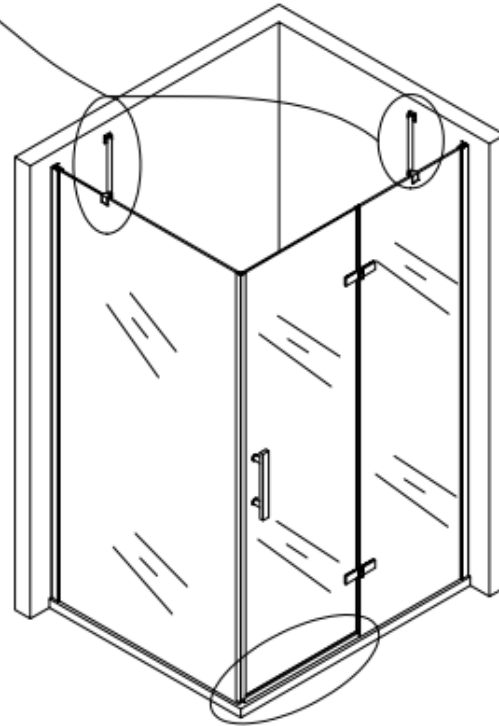
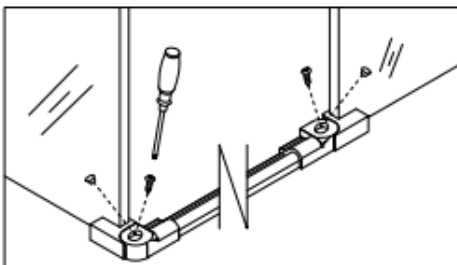
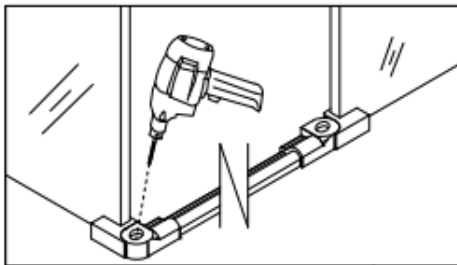
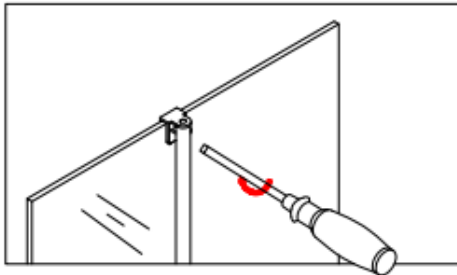
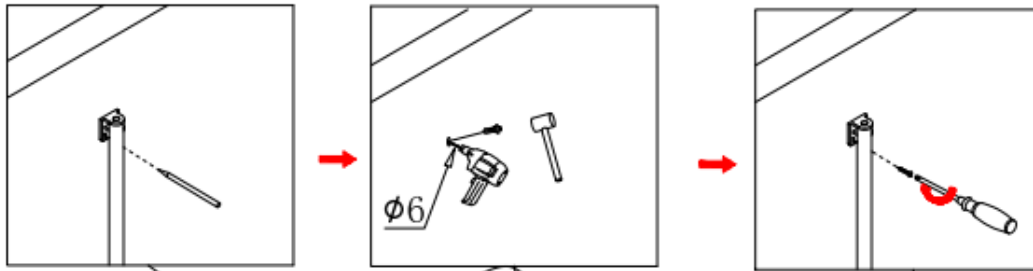
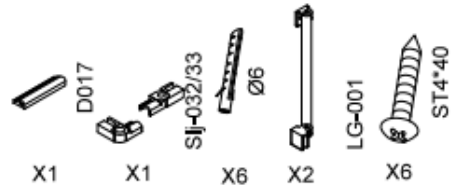
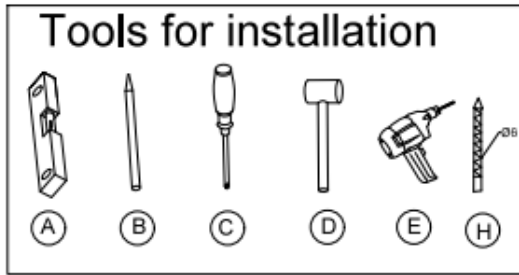

9. Place the supporting brackets into place, marking where holes will be drilled.
10. Drill holes and insert wall plugs, screwing the supporting brackets into place.
11. Attach the opposite end of the supporting bars onto the glass side panels.
12. Slide the glass fixing pieces into place, marking where holes will be drilled.
13. Drill holes and screw glass fixing pieces into position.

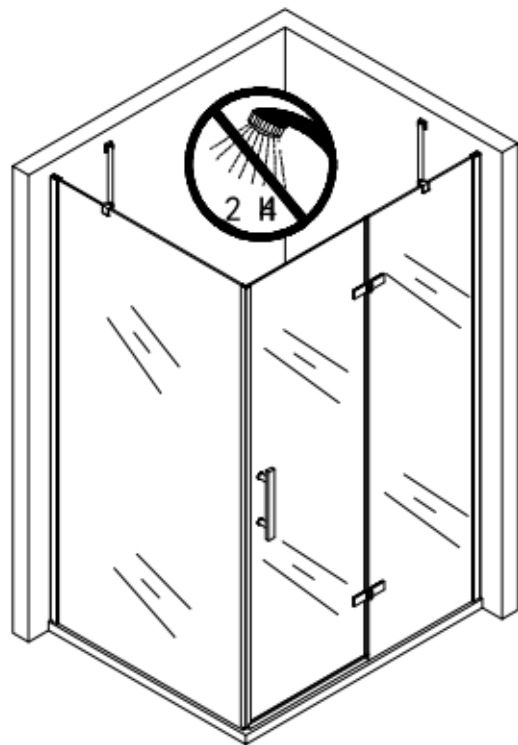
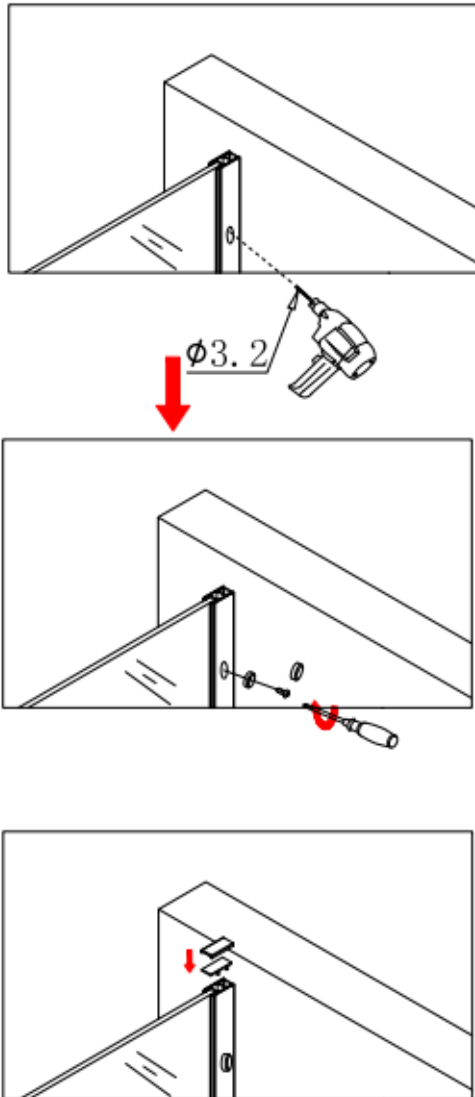
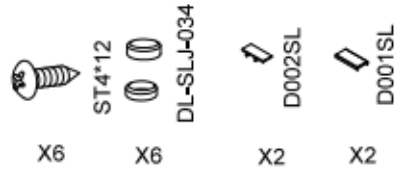
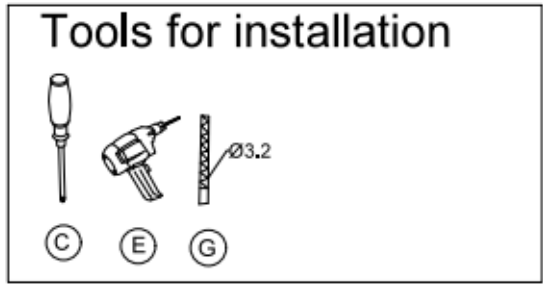

14. Drill a 3.2mm hole into the decorative aluminium strip, avoiding the glass and screwing it onto the aluminium bar.
15. Attach clips over the screws and on top of the aluminium bar.